



# AIRCRAFT ACCIDENT REPORT 03/15

## Air Accident Investigation Bureau

---

Report on the accident to Helicopter Dauphine,  
AS 365 N3 Registration 9M-IGB near Subang Airport,  
40 Nautical Miles Sout East of Subang Airport,  
MALAYSIA  
(N 03 00.64 E101 51.19)

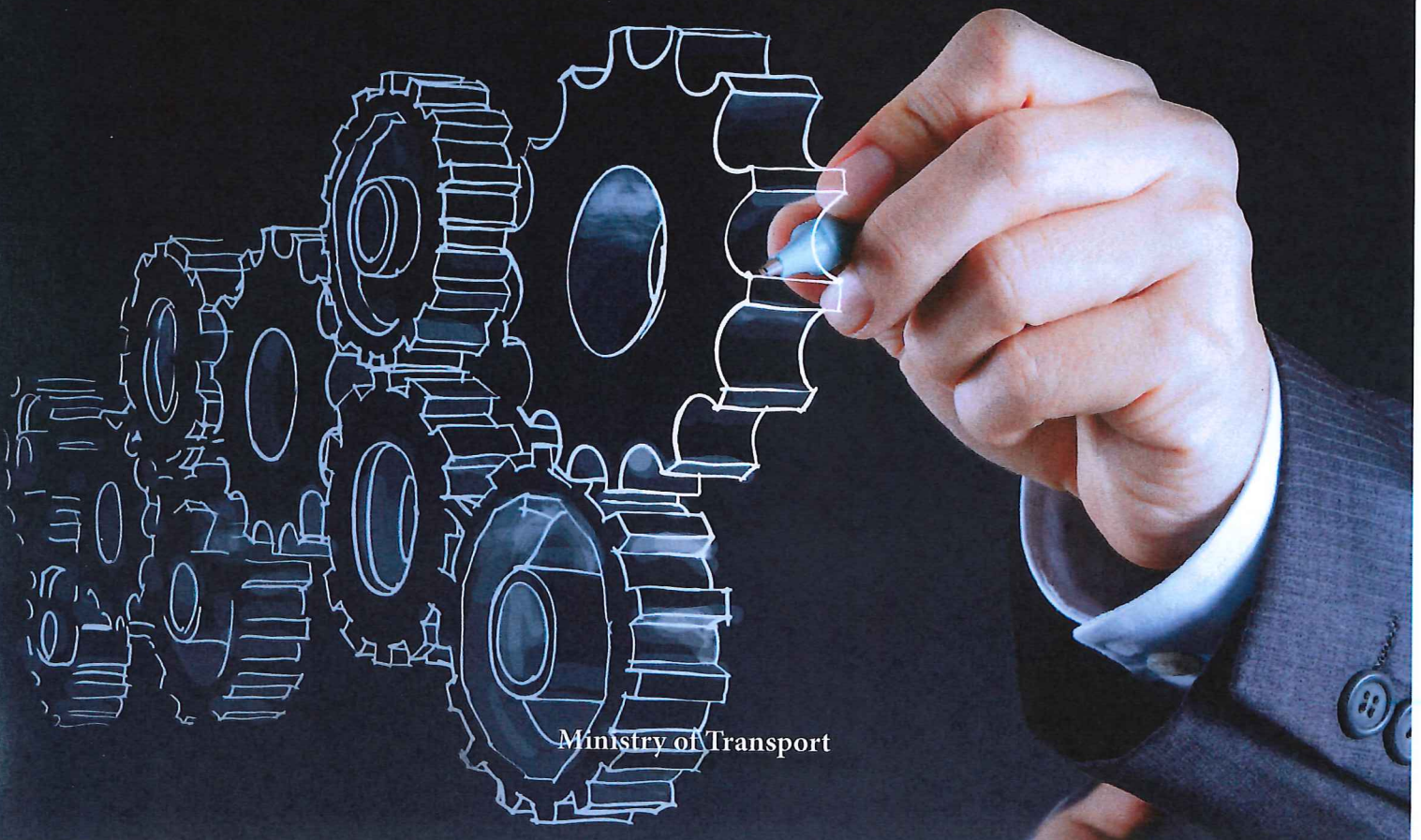

## AIRCRAFT ACCIDENT REPORT 03/15

Aircraft Type : Eurocopter Dauphin  
Model : AS 365N3  
Owner : Orion Corridor Sdn. Bhd.  
Nationality : Malaysian  
Year of Manufacture : 1990  
Aircraft Registration : 9M-IGB  
Serial Number : 6374  
State of Registration : Malaysia  
State of Operator : Malaysia  
Place and State of Occurrence : 40 Nautical Miles SE of Subang Airport, MALAYSIA (N 03 00.64 E101 51.19)  
Date and Time of Accident : 04 April, 2015 at 1654 hours (Local Time)

All times in this report are Local Time (LT) (UTC + 8 hours).

*This investigation is carried out to determine the circumstances and causes of the accident with a view to the preservation of life and the avoidance of accident in the future: It is not the purpose to apportion blame or liability. (Annex 13 to the Chicago Convention and Civil Aviation Regulation 1996).*

<b>CONTENTS</b>	<b>PAGE</b>
GLOSSARY OF ABBREVIATIONS	
SYNOPSIS	9
<b>1     <b>FACTUAL INFORMATION</b></b>	
1.1    History of the flight	11
1.2    Injuries of Persons	13
1.3    Damage to Aircraft	13
1.4    Other Damages	13
1.5    Personnel Information	14
1.5.1       Flight Crew Information	14
1.5.2       Pilot History	14
1.6    Aircraft Information	
1.6.1       General	15
1.6.2       Main Structural Component	16
1.6.3       Horizontal Stabilizer	17
1.6.4       Spoiler	17
1.6.5       The Step	18
1.6.6       Outboard Fin	19
1.6.7       Role of the Horizontal Stabilizer	20
1.6.8       Hydraulic Circuit	21
1.6.9       The Differences N2 N3	22
1.6.10      Aircraft History	22
1.6.11      Aircraft Maintenance History	24
1.6.12      Weight & Balance	25
1.6.13      Fuel	25
1.7    Meteorological Information	26
1.7.1       Metar Report	26
1.7.2       Station WMSA (Subang)	26
1.7.3       WMG5 (Station Petaling Jaya)	26
1.7.4       Weather Information	26
1.7.5       Radar Echoes	27
1.8    Aids to navigation	27
1.9    Communications	27
1.9.1      Very High Frequency (VHF) System	27
1.9.2      BA 1920 Passenger Interphone	27
1.9.3      TEAM TB31 Inter-Communication System (ICS)	28
1.10   Aerodrome Information	28
1.11   Flight Recorders	
1.11.1     Flight Data Recorder (FDR)	29
1.11.2     Flight Data Analysis	29
1.11.3     Underwater Locating Beacon	30

1.12	Wreckage and Impact Information	
1.12.1	General	30
1.12.2	Engine Inspections	30
1.12.3	Main Rotor Hub and Main Rotor Blades	31
1.12.4	Fenestron-Tail Rotor Section	31
1.13	Medical and Pathological Information	
1.13.1	Evacuation and Identification of Remains	33
1.13.2	Injuries to victims	33
1.13.3	Aircraft Commander	33
1.13.4	Female Passengers	33
1.14	Fire	33
1.15	Survival Aspects	33
1.16	Test and Research	34
1.16.1	Fluid Sample Test	34
1.16.2	Detailed Structure Examination	35
1.17	Organisational and Management Information	43
1.17.1	Aircraft Owner	43
1.17.2	Ground Handling Services	43
1.17.3	Orion Corridor Sdn. Bhd	43
1.18	Additional Information	
1.18.1	Stabilizer (VNE)	44
1.19	Useful or Effective Investigation Techniques	
1.19.1	Spectrum analysis audio data	45
1.19.2	Transcription	46
1.19.3	Flight Parameters-Data Quality	46
<b>2</b>	<b>ANALYSIS</b>	
2.1	Introduction	47
2.2	Commander's experience and qualification	49
2.3	Female Passenger	49
2.4	The landing and take-off from the open field	50
2.5	Stabiliser effect on aerodynamic	51
2.6	A piece of chipped-off paint found at the last landing point	52
2.7	The final disintegration	52
2.8	Engine recorder parameters	54
2.9	Operations under private flight	54
2.10	Pilot Licence	55
2.11	Authority on the flight deck	56
2.12	Maintenance	56
2.13	Recent similar accidents	56
2.14	Simulation on lost of horizontal stabiliser in flight	58

<b>3</b>	<b>CONCLUSIONS</b>	
3.1	Findings	60
3.2	Cause	61
<b>4</b>	<b>SAFETY RECOMMENDATIONS</b>	<b>62</b>

## **APPENDICES**

### **Appendix 1** International Flight Plan

### **Appendix 2**

- Figure 1 Route taken by the helicopter
- Figure 2 Landing at Muadzam Shah to visit abandoned factory
- Figure 3 Old Abundant Factory
- Figure 4 Sekolah Kebangsaan Ladang Kota Bahagia (football field) view of landing area
- Figure 5 Last Landing Point-Football Field

### **Appendix 3** CVR Transcript

### **Appendix 4** Wreckage Distribution

### **Appendix 5**

- Figure 1 Extensive damage to main rotor blades
- Figure 2 Extensive damage to main rotor blade root
- Figure 3 Separation of the main rotor blade under high rotational Speed
- Figure 4 Severe damage on the lower part of the fenestron
- Figure 5 Broken tail rotor blades under high rotational speed
- Figure 6 Broken blades due to sudden impact with the fenestron Casing
- Figure 7 Engine condition, Serial Number: 4270
- Figure 8 Several nicks on the compressor blades
- Figure 9 Manufacturer's alignment marks on the spline and base Mount
- Figure 10 Severely bent and jagged compressor blades due to ingress of FODS
- Figure 11 Boroscope inspection around the impellor section
- Figure 12 Post impact fire on the engine
- Figure 13 Condition of Main Rotor Head
- Figure 14 Condition of Main Rotor Gearbox
- Figure 15 Condition of the covered parts
- Figure 16 Parts recovered along the aircraft trajectory (some of them were found on the top of some trees)
- Figure 17 Positioning of the parts in relation to their location on the Aircraft

### **Appendix 6**

- Figure 1 3 impact evidences on the rear part of the airframe
- Figure 2 3 impact evidences on the rear part of the airframe
- Figure 3 1 impact on the fenestron frame (+ tail drive shaft) & on engine cowling
- Figure 4 1 impact evidence on the tail boom (+ tail drive shaft) & engine cowling & exhaust pipes
- Figure 5 1 impact evidence on the left side cabin door & forward cowling

## **Appendix 7**

- Figure 1 CPPI from KLIA Doppler Radar (3-5.30 pm)
- Figure 2 CPPI from KLIA Doppler Radar (3-5.30 pm)
- Figure 3 Satellite image MTSAT at 5.32pm

## **Appendix 8**

- Figure 1 Landing in the open field-Acoustic event appearances sound and warning description (spectrum overview)
- Figure 2 The audio files used are "CAM last minutes.wav"
- Figure 3 9M-IGB –Propulsion system condition (last minute of recording) spectrum overview
- Figure 4 The audio file is "CAM 0133 to 0137.wav"

## **Appendix 9**

- Figure 1 Flight Parameters-End of flight (engines)
- Figure 2 Landing at open field parameters
- Figure 3 Flight parameters - zoom
- Figure 4 Landing at open field parameters
- Figure 5 Flight parameters
- Figure 6 End of flight parameters
- Figure 7 End of flight parameters
- Figure 8 End of flight parameters - zoom
- Figure 9 On ground parameters
- Figure 10 End of flight parameters
- Figure 11 After landing open field parameters

## **Appendix 10**

Private Pilot's Licence (Helicopters and Gyroplanes)

## **Appendix 11**

Daily Inspection Authorisation

## **Appendix 12**

Landing at open field at 08.20

## **Appendix 13**

Final Disintegration from FDR Analysis

## **Appendix 14**

Letter from DGCA

## **Appendix 15**

Comments from BEA, France

## **GLOSSARY OF ABBREVIATION**

AIB	Air Accidents Investigation Branch
AOC	Air Operator Certificate
AMM	Aircraft Maintenance Manual
ALT	Altitude mode on Auto Pilot
BEA	Bureau d'Enquetes et d'Analyses
CAM	Cockpit Area Microphone
CVR/FDR	Cockpit Voice Recorder/Flight Data Recorder
CMR	Certificate of Maintenance Review
CG	Centre of Gravity
DVI	Disaster Victim Identification
DECU	Digital Engine Control Unit
ENT	Ear Nose and Throat
ESM	Electronic Scanning Microscope
FAA	Federal Aviation Administration
HS	Horizontal Stabiliser
ICS	Inter- communication System
IAS	Indicated Air Speed
LT	Local Time (UTC+ 8 hours)
MRR/MTC	Airframe Repair Manual/ Standard Practice Manual
METAR	Routine Weather Report Provided at Fixed Interval
MGB	Main Gear Box
NACA	National Advisory Committee for Aeronautic
OEI	One Engine Inoperative
PFD	Primary Flight Display
SK LKB	Sekolah Kebangsaan Ladang Kota Bahagia (Open Field)



SSCVFDR	Solid State Combination Cockpit Voice and Flight Data Recorder
STRIDE	Science and Technology Research Institute for defence
TCAS	Traffic alert and Collision Avoidance System
ULB	Under water Locating Beacon
VIP	Very Important Person
VHF	Very High Frequency
VNE	Velocity Never Exceed

## **SYNOPSIS**

On the 4<sup>th</sup> April, 2015 a Dauphin helicopter, AS365 N3 bearing registration 9M-IGB was on a private flight carrying 7 passengers from Pekan, Pahang at 1540 LT to Muadzam Shah. The flight was to transport passengers who had attended a series of meetings and wedding reception at Pekan. It landed Muadzam Shah at 1600 LT with engine shut down for approximately 10 minutes. It then flew towards South Westerly direction with intention to land at Bandar Tun Razak with the same number of passengers on board. While en route, it started to rain towards the destination. Due to the unfavorable weather condition, a decision was made by one of the passengers not to proceed to the destination; however, they decided to proceed direct to Subang. Since one of the passengers had to stay back at Muadzam Shah, the helicopter then landed at a football field along the main road to off load him. While landing at the football field, the left landing gear suddenly sunk into the ground. The pilot subsequently maneuvered the helicopter to a hover, and repositioned it about 10 meters forward. One passenger disembarked from the right passenger door and the helicopter took-off from the field on westerly heading en route to Subang airport. With 6 passengers onboard, it climbed to 2,000 feet. After passing Kuala Klawang, the helicopter made a last recorded radio call and started to descend to 1,500 feet. According to an eye witness report on ground, he saw the helicopter suddenly making a steep dive and crashed into a rubber tree plantation.

A pilot of another helicopter, an EC155, flying from the south, who was earlier in communication with the ill-fated helicopter, saw the helicopter made a steep dive to the ground followed by black smoke. The ill-fated helicopter altitude based on the TCAS of EC 155 was estimated to be at approximately 1,700 feet. Upon observing the helicopter had crashed to the ground, the pilot of the EC155 made a radio call on the operating frequency and informed the sighting to Lumpur Information. There was no distress call made by the crew of the ill-fated helicopter on any of the operating frequency.

Several witnesses on ground also claimed that they heard a loud noise from the helicopter followed by steep descend to the ground. The helicopter crashed into a ravine and caught fire. All occupants were fatally injured.

The Chief Inspector of Air Accident Investigation Bureau was informed immediately of the accident. An Investigation team was appointed by the Minister of Transport which comprise of 9 members headed by Captain Dato Yahaya bin Abdul Rahman as the Investigator-In- Charge. The investigation begun at the crash site on the 5<sup>th</sup> April, 2015.

The investigation was assisted by BEA, France as Accredited Representative. The Air Accident Investigation Branch of the United Kingdom was also involved in the downloading of the SSCVFDR.

## **1. FACTUAL INFORMATION**

### **1.1 History of the flight.**

A privately owned helicopter, Dauphin AS365 N3, registration 9M-IGB departed Subang Airport on the 2<sup>nd</sup> April, 2015 at 1815 LT for Tanjung Gemok, Rompin, Pahang, with a pilot and 3 passengers on board. From Tanjung Gemok, after 2 of the passengers disembarked, the pilot and a female passenger continued to depart for Lanjut, Pahang and arrived at 1930 LT for an overnight stay.

*(For easy reference of this report, the subsequent helicopter registration will be termed as IGB).*

On the 3<sup>rd</sup> April, 2015, at 0902 LT, IGB departed Lanjut with the pilot and the same female passenger occupying the front left hand seat. It flew to Tanjung Gemok to pick up 3 passengers and then to Muadzam Shah. It stayed on ground at both location for approximately 15 minutes and departed for Kuantan Airport at 1510 LT. It arrived Kuantan Airport at 1532 LT. After disembarking all the passengers, it departed Kuantan Airport with 2 persons on board, the female pilot and a passenger, departed for Kerteh Airport, Terengganu. At Kerteh, the crew refueled the helicopter with 935 liters of aviation fuel (Avtur). It flew back to Kuantan airport and landed at 1700 LT for a night stay.

On the 4<sup>th</sup> April, 2015, it departed Kuantan airport at 1141 LT as per flight plan shown in Appendix 1, with the same pilot and the female passenger en-route to Pekan. The short flight to Pekan was to pick up passengers for onward flight back to Subang. It landed Pekan at 1213 LT and stayed on ground for more than 3 hours. 5 joining passengers boarded the helicopter with the female passenger occupying the front left seat. It departed Pekan at 1540 LT for Muadzam Shah. The flight was uneventful and on arriving Muadzam Shah, one of the passengers suggested to land at an area near an abandoned factory for 5 minutes. The engines and rotors were shut down to allow the passengers to disembark to view the abandoned factory building. At 1600 LT, all the 6 passengers boarded the helicopter, with the pilot occupying the front right seat and the female passenger occupying the front left seat.

The helicopter departed Muadzam Shah at 1610 LT with 7 persons on board. Initially it was flying towards a South Westerly heading to a town called Bandar Tun Razak in Rompin district. The Cockpit Voice Recorder (CVR) information revealed that after getting airborne, one of the passengers was not happy with the weather condition en-route to the destination. On several

occasions, he was suggesting to the pilot to proceed direct to Kuala Lumpur. However, after a short discussion, they concurred to off load one of the passengers originally destined for Bandar Tun Razak, at any open field along the way. While flying along the road en-route to Kuala Lumpur, they spotted a football field and executed an approach for a landing.

During the final approach, there was moment of silence in the intercom until the helicopter was getting close to the ground for the landing. Upon landing, the CVR picked up a loud “thud’ sound which alerted the passengers. One of the passengers commented in the intercom system by saying ‘watch out’ twice. The pilot was uncertain on the landing gear position by saying “why my landing gear... is it down? I got three in the green, I am little nervous about this now, let me see it”. The female passenger was heard in the intercom by saying “it’s ok... it’s a... the dirt at the back... its ok...”. The female passenger continues “wheel went into the ground..., it’s a soft ground there.. after the rain .. we are good, we are good.. yes.. yes.. yes, we are good; it’s a soft ground there.. after the rain.. it’s the field... it’s the football field. The pilot then commented “wow... that was crazy”.

According to a witness statement, he saw the helicopter left wheel sunk into the ground and the helicopter tilted to the left. Shortly afterward, the helicopter was seen to take off to a high hover and repositioned to approximately 10 meters to the front of its last position. One passenger disembarked the helicopter while both engines and the main rotors were still running and he exited via the right door escorted by the pilot. Shortly afterward at 1625 LT, the helicopter took off from the field. As it climbed to a cruising altitude, the lady passenger commented through the intercom “Don’t worry, we absolutely safe”. The lady passenger reminded the pilot “shall we collapse our gear” and the pilot responded “no.. no.. no .. leave it down, there is probably some damage to the hydraulic or something” The pilot said “we went all the way to the belly, it’s not good”. He further said “it’s definitely not normal for the wheels go down into the ground that far”. It’s definitely not good to tip like that”. He said “as a matter of fact, I saw hydraulic fluid leaking and that’s why I don’t want to put them up”. They are locked in the down position and we keep them locked in the down position”.(See CVR transcript at Appendix 3)

At 16:31 LT, a radio call to Lumpur Information on frequency 126.1 Mhz was made by the pilot that he had passed Muadzam and Bandar Tun Razak, tracking for Kuala Klawang at 2,000 feet and below with 6 persons on board and endurance of 1 hour 45 minutes.

At the same time, there was another helicopter, EC155 registration 9M-DBI flying from Johor Bahru to Subang. There was communication between the two pilots to maintain a safe separation.

At 16:52 LT, IGB disappeared from the radar screen and at 16:54 LT, 9M-DBI made a radio call to Lumpur informing that IGB had crashed.

From the Air Traffic Control record, there was no distress call made by the pilot on any operating radio frequency.

The helicopter was found crashed in a ravine at a rubber plantation, Kampung Sungai Pening-Pening, Semenyih approximately 40 nautical miles to the East of Subang Airport. All the 6 occupants were fatally injured. The route flown are shown in Appendix 2, Fig 1.

## **1.2 Injuries To Persons**

Following are the numbers and the injuries to the crew and passenger:

Fatality	Crew	Passenger
6	1	5

## **1.3 Damage To Aircraft**

The aircraft wreckage was significantly damaged by the impact forces and the post-crash fire at the bottom of a ravine. Many of the aircraft parts including MGB and engine cowling, engine exhaust pipe, main rotor head and blades, entire fenestron, main landing gears and fuselage doors were collected from a distance of about 300 metres from the main wreckage along the steep slope of the hills. The parts recovered were on the suspected trajectory of the route flown. No evidence of aircraft contact with the terrain until the vertical impact of the main wreckage. All the parts recovered have been made available for examination in a hangar. The helicopter was destroyed due to high impact and consumed by post crash fire. (See wreckage distribution at Appendix 4)

## **1.4 Other Damages**

Nil

## 1.5 Personnel Information

1.5.1 The following are pertinent information related to the flight crew.

Status	Commander
Nationality	American
Age	47 Years old
Gender	Male
Licence Type	CPL 2762/H
Medical Examination	Valid until 31 September 2015
Aircraft Rating	R22, R44, R66, AS 365N3
Certificate of Test	4 November 2014
Instructor Rating	R44 & R66
Flying Experience	Total flying : 2,487:07 Hours Total on type : 188 Hours (AS 365 N3)

### 1.5.2 Pilot history

The pilot received his student pilot certificate on 28 May 1997 (3<sup>rd</sup> class medical) with 17 hours of flight time. On 02 June 2000, he received a 2<sup>nd</sup> class medical with 300 hours of flight time, listing a commercial certificate. His occupation was listed as sales for Power Sports. On 27 April 2001, he had 650 hours and listed Solaire Systems as his employer.

He was diagnosed with a problem in his left eye that stemmed from a minor myopia back in 1998; saw an ophthalmologist, and subsequently passed a 1<sup>st</sup> class medical on 6 July 2001. From 06 June 2001 to 7 August 2002, he listed "self" as employer.

From 25 July 2003 to present, he was employed by Solaire as his employer.

On 25 July 2003 he was diagnosed with a minor high tone hearing defect, saw an ENT, and passed his 1st class medical. His medical records recommend the use of hearing protection on him.

On 3 November 2007, he was involved in a motor bike accident in Kuala Lumpur and was admitted to the hospital. He had some head injury with no concussion, broken ribs, abdomen and limb contusions, and was intubated and ventilated. On 16 March 2007, he had an elective tracheostomy. Medical records indicated a full recovery. He then received a 1<sup>st</sup> class medical on 8 October 2007. From 2007 to present, his medical records appear normal.

Earlier application records indicate he had some flying experience in the Marines prior to civilian flying. His last Certificate of Test was done on 4 November 2014 and still valid.

## **1.6 Aircraft Information**

### **1.6.1 General**

The AS 365 N3 is also known as Helicopter Dauphin 2. It is a twin engine helicopter fitted with 2 Arriel 2C modular design free turbine turbo shaft engines. It is designed for passenger transport, offshore, rescue and aerial work operations. It is fitted with with standard seat of 1 pilot and 9 passengers.





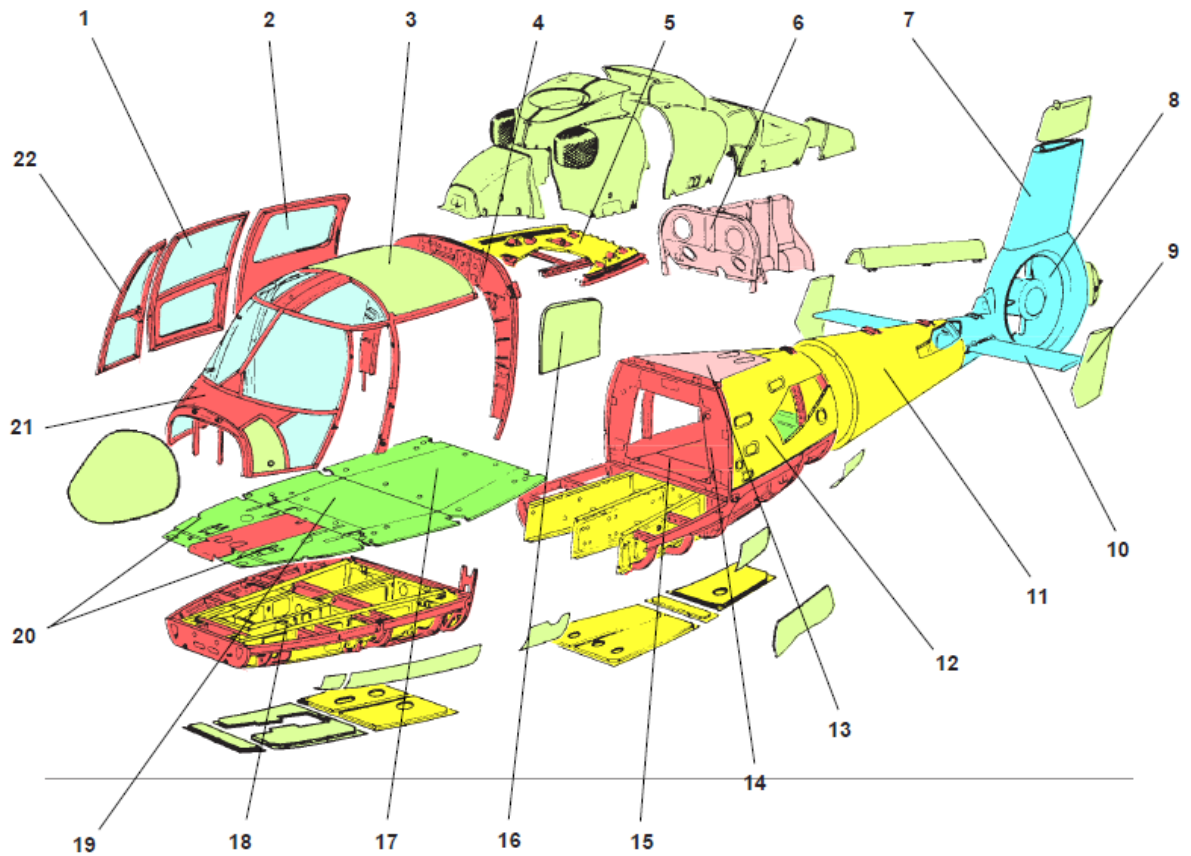

The helicopter is fitted with with 4 composite material main rotor blades aerofoil of high aerodynamic efficiency. The tail rotor is of fenestron design with 10 blades. The landing gear is of retractable tricycle type. It is complete with oleopneumatic shock absorber and hydraulic actuating cylinder. The nose landing gear is able to automatic centring and casting lock control. The hydraulic power generating system pumps are driven by the maingearbox and an electrical driven pump for emergency landing gear extention.

It is fitted with 2 fuel tanks groups and 2 booster pumps per engine which draw fuel from the feeder tank in each group. There is 1 transfer pump between the groups.



## 1.6.2 Main Structural Components



- |   |  |  |  |
|---|--|--|--|
|  | Light alloy  |  | Metal honeycomb, metal skin sandwich structure |
|  | Composite material : Fiberglass Kevlar or Nomex sandwich structure |  | Titanium                                       |
|  | Nomex honeycomb, metal skin sandwich structure                     |  | Carbon fabric                                  |
|   |  |  | Plexiglas                                      |

<p>1 - Front passengers' door  2 - Rear passengers' door  3 - Ceiling  4 - 9° frame. Bears the attachment fitting of MGB front tie-bars  5 - Transmission deck  6 - Firewalls  7 - Fin  8 - "Fenestron" duct  9 - Outboard fin  10 - Horizontal stabilizer  11 - Tail boom. It is a buoyancy reserve  12 - Body structure</p>	<p>13 - Engine deck.  14 - Frame at station 4630. Bears the attachment fitting of MGB rear tie-bars and main landing gear attachment fitting.  15 - Hold floor. Acces to the rear fuel tank.  16 - Hold door. RH side only.  17 - Cabin rear floor. Acces to the central fuel tanks  18 - Hull.  19 - Cockpit floor. Acces to the front fuel tanks.  20 - Cabin forward floor.  21 - Forward structure. Canopy  22 - Pilot's door. Co-pilot's door opposite handed.</p>
---	---

Fig 1

### 1.6.3 The horizontal stabiliser

The horizontal stabiliser (HS) is made up of one piece carbon fibre which passes through perpendicular to the aft of the tail boom. The function is to counter any changes in the helicopter attitude and to bring the helicopter back to its original attitude should it have deviated from it. At both ends fitted with two NOMEX sandwich structure side fins. Its asymmetrical NACA aerofoil, set at  $2 \square 45'$  with respect to the helicopter datum. Under action of the relative wind  $V$  it will create an aerodynamic forces  $F$  which tends to stabilise the helicopter back to a comfortable level attitude. In order to improve its performance, the HS is fitted with a Spoiler (5) on its leading edge and a step (4) on the trailing edge. (See Fig 3)

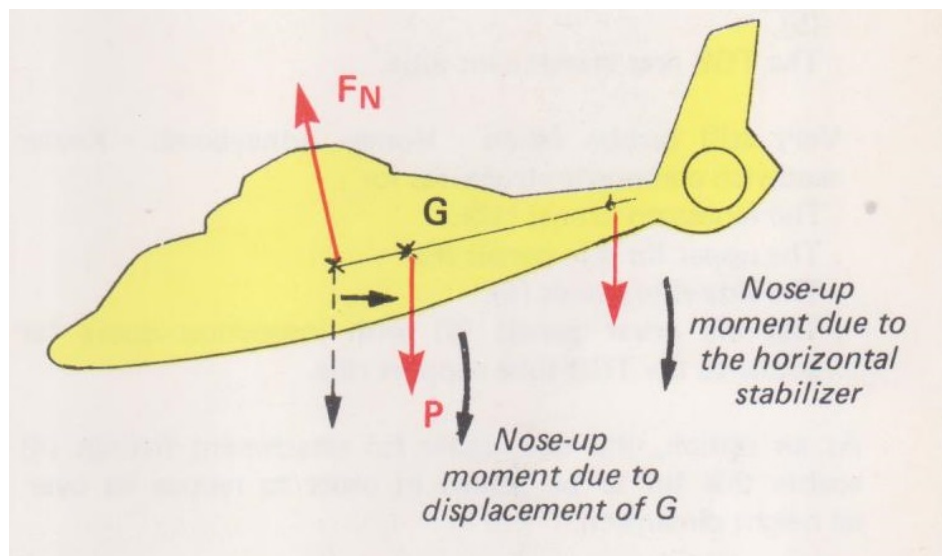

Fig. 2

#### 1.6.4 Spoiler

During flight, the reduction in fuel weight causes the helicopter centre of gravity to move aft. The displacement of CG will create a nose up movement which is added to that caused by the action of HS. The spoiler on the leading edge acts as a detector when the helicopter reaches the horizontal position, the stream line flow breaks, the forces  $F$  is reduced as is the nose up movement. This process enable the minimum permissible weight to be reduced without affecting the helicopter performance. (See Fig 3)

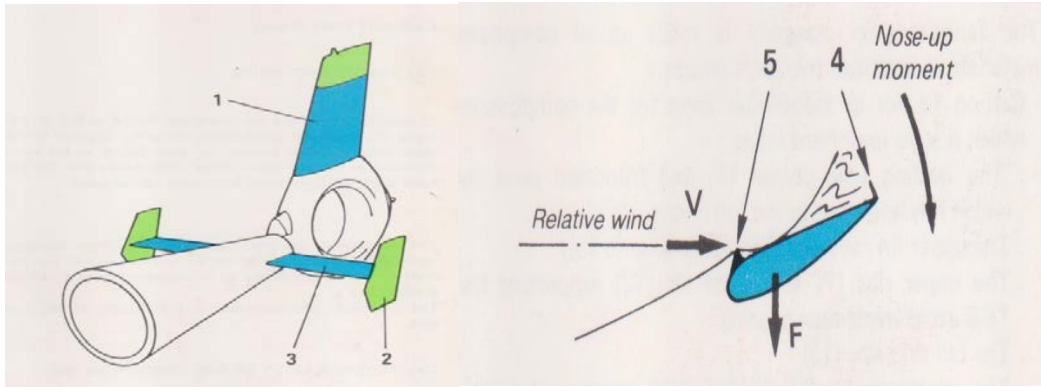

Fig. 3

### 1.6.5 The step

The aerodynamic forces exerted on the HS depends on its surface area, the greater the surface area the more the forces increases. The steps enable the HS to be increased artificially by forcing the streamline flow back on to the aerofoil, under the suction pressure it creates. (See Fig 4)

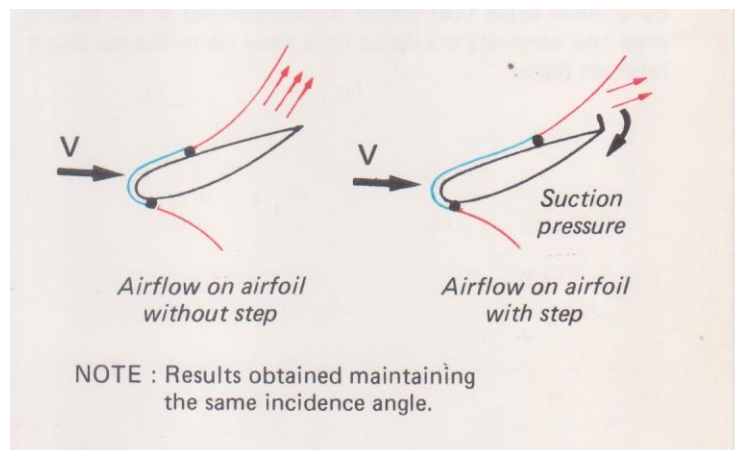

Fig. 4

### 1.6.6 Outboard fin

The HS outboard fins have opposite hand aerofoil. They are set at 5° with respect to the helicopter centreline and create aerodynamic forces  $F_2$ . The outboard fins contribute to the stability on the yaw axis.

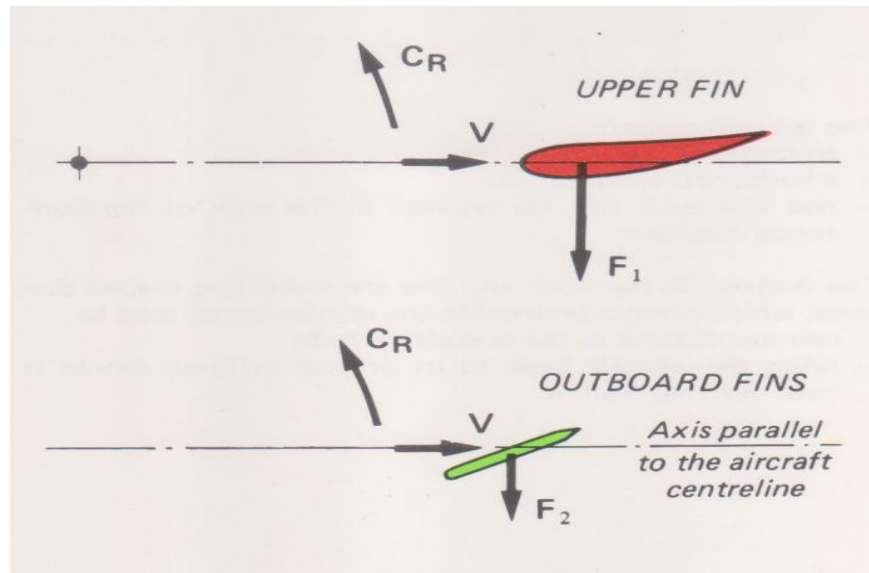

Fig. 5

1.6.7 The horizontal stabiliser creates a pitch up moment aerodynamically in order to establish a comfortable pitch attitude during high speed flight (See Fig 6)

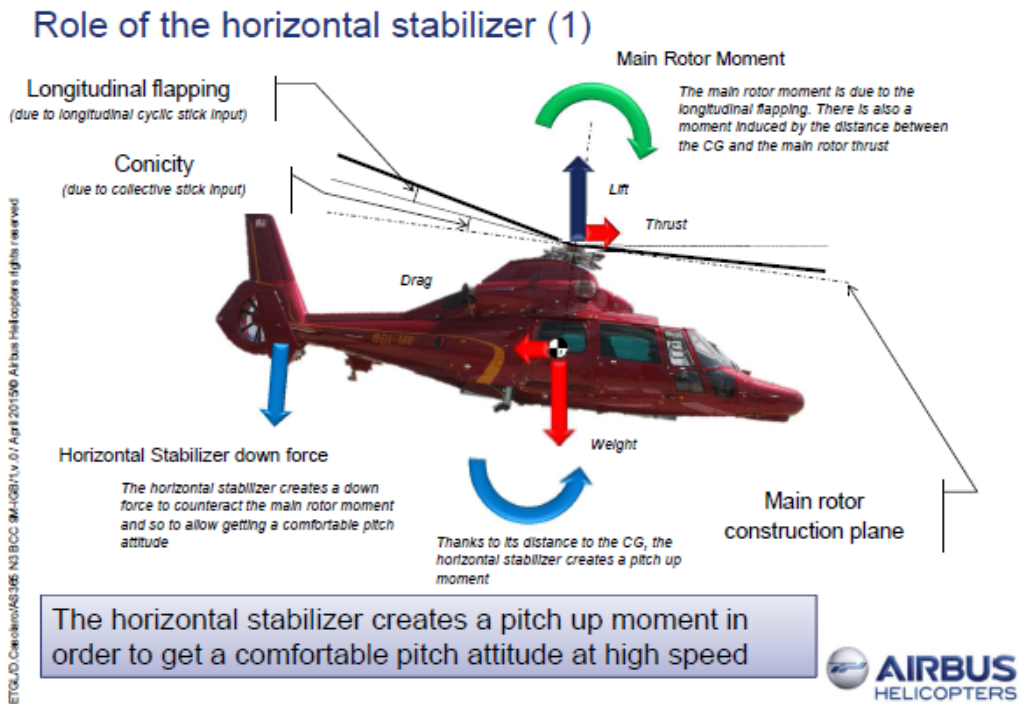

Fig.6

1.6.8 With the rotor running and landing gear down position, the hydraulic brake pressure is supplied by the auxiliary hydraulic power system (18 litres/minutes) up to a maximum of 130 bars at which the pressure switch open (See Fig 7 and Fig 8)

# Hydraulic circuits

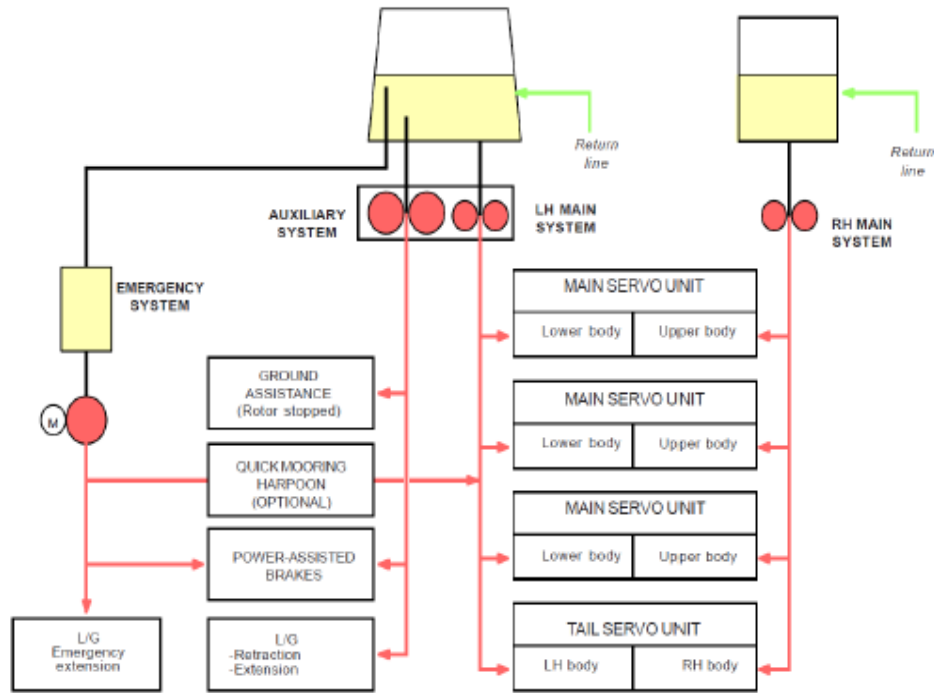

Fig. 7

# Hydraulic circuits

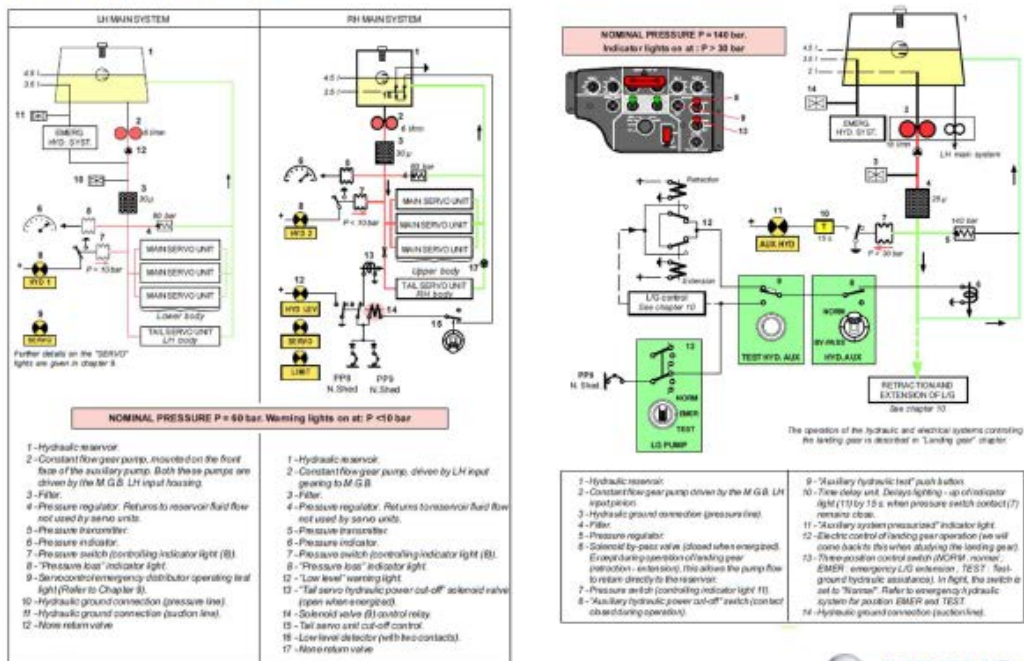

Fig. 8

1.6.9 The differences between the Helicopter Dauphin N2 and N3 are as follows;

Both models are similar in dimensions except that most N3s (later models) will have a longer nose, both models may have a 10 or 11-bladed tail rotor, most N3s have 10-bladed tail rotor as standard, the 10-bladed tail rotor is available as an option to replace the 11-bladed tail rotor. The N3 has a higher MTOW of 50kgs compared to the N2, the main differences on the engines are;

- a. N2 fitted with 2 x Turbomeca Arriel 1C2, manually controlled, 551kW
- b. N3 fitted with 2 x Turbomeca Arriel 2C, controlled by Digital Engine Control Unit (DECU), with manual backup, 625kW
- c. The N3 uses electronic flight instruments unlike the analogue-type on the N2
- d. The N3 does not have an airframe fuel filter,
- e. Layout of switches in the cockpit differ between both models,
- f. Hydraulic system caution lights are similar but are in red on the N2 and amber on the N3.

#### 1.6.10 Aircraft history

##### Event 1

On 16 July 1991 at 412.42, airframe hours. There was a repair request from ASESА following the fall of a metal sheet from the hangar roof on the helicopter. The Fenestron was damaged. There was no damage on the horizontal stabilizer.

##### Event 2

On 19 May 1993 at 1,845 airframe hours, the aircraft was used by a politician for his political visit. During the visit, there was an unrest whereby the crowd had thrown stones towards the helicopter. The aircraft made an OEI take-off which could not be controlled by the pilot and it collided into a wall and damaged some parts of the helicopter. Based on the recorded repair scheme, the area close to the footsteps of the helicopter was repaired.

The repair and replacement of damaged parts was carried out in accordance with the MRR / MTC (Airframe Repair Manual/ Standard Practices Manual). The MTC contains procedures for repairs whilst the MRR contains minor repairs that the Maintenance Centers can carry out if the damage is within



the acceptable limitations. If the damage is too extensive, AH may create a dedicated repair scheme. If the damage is not within criteria and AH doesn't provide a repair scheme then the component must be scrapped and replaced. Since no repair scheme could be found and the damage was too extensive to be handled by MTC/MRR, the horizontal stabilizer had probably been replaced.

### Event 3

On 12 September 1996 at 3,235 airframe hours, after landing on a platform, the left landing gear had retracted. The tail bumper and the left vertical fin of the horizontal stabilizer were damaged. The aircraft flew back to land where components were replaced / repaired according to MRR/MTC. Since no repair schemes could be found and the damage was too extensive to be handled by MTC/MRR, the left vertical fin had probably been replaced. The aircraft had flown for 3,000 hours after the repair works before it was grounded without any issue. From 2001 to 2003, the aircraft was grounded at ASES-SAEMSA premises and was forbidden to fly due to financial dispute between ASES-SAEMSA with Airbus Helicopters. Only basic preservation was carried out. In 2003, few of the 11 Dauphins operated by ASES-SAEMSA were returned to Airbus Helicopters in financial compensation. This includes the SN 6374.

From 2003-2005, Airbus Helicopters were looking for prospective buyers of second hand helicopters before carrying out the necessary periodical overhaul. In 2006, in order to train AH Malaysia to do major periodical inspections and conversion retrofits on the Dauphin family, two helicopters were delivered to AH Malaysia. For this reason, the overall timeframe may be longer than usual. From 2006-2008, the helicopter SN6374 was brought to AH Malaysia facilities for inspection where it was completely paint stripped, thoroughly inspected and examined to prepare the helicopter for a full work scope. Frequent sessions were made with AH experts to confirm the assessments.

From 2009-2012, 3 work packages were carried out in parallel at 5,400 hours INSPECTION as defined in the PRE (Master Servicing Manual). Several photos of each sub component were taken for analysis and validation from AH to justify the decision making process, component reused, repaired or replaced. Priority was given to replacement of components over possible component repair. It was emphasized that for - REPAIR SCHEME: this concerned only the main structure, not the tail boom area. All components and work sheets were prepared in AH and sent to Malaysia.

CONVERSION from As 365 N2 to N3: the L2 (the work package that list operations to be performed) includes work sheets and components that were prepared at AH to be sent to Malaysia. Due to the extensive work being carried out, the work scope was equivalent to a full re-assembly than a periodic inspection. The ground tests carried out were as extensive as the ones carried out at the end of the assembly lines. During that period, the vertical fins of the horizontal stabilizers were replaced by new ones. The horizontal stabilizer was inspected in detail as per AMM but not replaced nor repaired as it did not require a repair scheme or a replacement. The horizontal stabilizer was therefore returned to flight as is basis and considered fully airworthy.

On 09 February 2012 at 5,900 airframe hours, Airbus Helicopters Malaysia returned the helicopter status to "Available for flight" for SN6374. The helicopter was made airworthy for flight.

On 15 March 2012, AS 365 N3, 9M-IGB was put in service under Orion Corridor Sdn Bhd as a new owner.

#### 1.6.11 Aircraft Maintenance History

Helicopter Registration	-	9M-IGB
Helicopter Serial Number	-	6374
Engine No. 1 Serial Number	-	24477
Engine No. 2 Serial Number	-	24479
Certificate of Registration	-	M1714
Certificate of Airworthiness:	-	M1475

The helicopter maintenance was carried out by Airbus Helicopters Malaysia Sdn. Bhd. based in Subang Airport.

The last Certificate of Maintenance Release to Service – Schedule Maintenance Inspection (CRS-SMI) was issued on 20<sup>th</sup> January, 2015.

Aircraft Last check	:	1 year and 6 months inspection,
Airframe Hours	:	6,331:04
Engine No. 1 Hours	:	437.04
Engine No. 2 Hours	:	437.04

Last Certificate of Maintenance Review (CMR No: 554) was carried out on 7<sup>th</sup> January, 2015

#### 1.6.12 Weight and Balance

The helicopter weighing check was carried out on 31<sup>st</sup> May, 2012 after a major interior modification to install the VIP seats at the Airbus Helicopter hangar at Subang Airport. The aircraft Weight Schedule, dated 8<sup>th</sup> June, 2012 was reviewed with the following pertinent details.

Basic Empty Weight (BEW) of 2,791.50 kg.

Centre of Gravity (C of G); Longitudinal 4.153 meter and Lateral -0.0025 meter

Weight limitations (maximum authorised weight in flight) are 4,300 kg.

Name	Weight (kg)	Moment (kg.m)		Comment
		Long	Lat	
Basic Weight	2791,5	11593,527	-7,099	Weight and Balance report
Pilot	80	157,6	31,76	
Co-Pilot	60	118,2	-23,82	
Pax 1	70	212,1		
Pax 2	70	212,1		
Pax 3	70	296,8		
Pax 4	70	296,8		
Fuel G1	174	562,02		
Fuel G2	174	812,58		
Total	3559,5	14261,727		

Weight	3559,5	Kg
Xcg	4,01	m
Ycg	0,00	m

This indicates the weight and balance of the aircraft was within the allowable limits.

#### 1.6.13 Fuel

The helicopter was refueled at Petronas Kerteh station on 3<sup>rd</sup> April, 2015. Amount up-lifted 935 Litres.

## 1.7 Meteorological Information

### 1.7.1 Metar Report Based on STATION WMKK (KLIA)

METAR WMKK 040800Z 20006KT 120V270 9999 FEW017CB BKN280  
34/24 Q1004 NOSIG=

METAR WMKK 040830Z 20008KT 150V250 9999 FEW017CB BKN280  
Q1004 NOSIG=

METAR WMKK 040900Z 19007KT 140V240 9999 FEW017CB BKN280  
32/24 Q1003 NOSIG=

METAR WMKK 040930Z 19006KT 9999 FEW017CB BKN280 32/24 Q1003  
NOSIG=

METAR WMKK 041000Z 22005KT 180V260 9000 TS FEW017CB BKN280  
32/25 Q1004 NOSIG=

### 1.7.2 STATION WMSA (SUBANG)

METAR WMSA 040800Z 24008KT 8000 FEW017CB SCT020 BKN270  
34/26 Q1004=

SPECI WMSA 040832Z 25010KT 3500 -TSRA FEW005 FEW017CB  
SCT025 OVC260 32/26 Q1003 RMK F95 1CB OVH tlo OVH=

METAR WMSA 040900Z 29011KT 5000 -TSRA FEW008 FEW017CB  
SCT025 OVC260 29/26 Q1004

SPECI WMSA 040923Z 16007KT 1500 TSRA FEW000 FEW017CB SCT026  
OVC260 26/24 Q1005 RMK F95 2CB OVH tlo OVH=

METAR WMSA 041000Z 24005KT 5000 -TSRA FEW008 FEW017CB  
SCT025 OVC260 25/23 Q1005=

### 1.7.3 WMG5 (STATION PETALING JAYA)

METAR WMG5 040800Z 23004KT 180V330 9000 FEW018CB SCT160  
BKN300 35/24 Q//// QFF1002 RMK F05 P00.0 R50 1CB N-NE z A/R=

METAR WMG5 040900Z 30011G22KT 180V350 3000 +TSRA FEW017CB  
SCT150 BKN290 27/23 Q//// QFF1003 RMK F95 P08.0 R79 1CB N-NE+SE  
tlo + I N-NE=

METAR WMG5 041000Z 25003KT 6000 -TSRA FEW005 FEW017CB  
SCT150 BKN290 26/23 Q//// QFF1003 RMK F95 P07.0 R83 1CB N-NE tlo  
N-NE=

1.7.4 The weather information and observation, there was group of rain clouds forming in the northern part of the accident location. There were clouds moving toward the southwest (west location of the accident) with increasing intensity after 5pm. (See weather information and satellite Image at Appendix 7)

1.7.5 Based on radar echoes, cloud group does not have high intensity before 1700LT. Cumulonimbus large cloud with high intensity seems more concentrated in the western state of Johor, southern Pahang, Kuala Lumpur Federal Territory and part of Selangor in district of Petaling and Klang. The weather has no bearing towards the accident.

## **1.8 Aids to navigation**

Not applicable.

## **1.9 Communications**

### **1.9.1 Very High Frequency (VHF) System**

The aircraft was installed with two King KTR 908 VHF System (VHF1 and VHF 2). Each assembly comprises of three components; a transceiver unit, a control unit and an antenna. The receiver is used to establish air-to-air and air-to-ground radio-telephone communications using very short waves.

The VHF 1 installation is supplied with 28 VDC via a 10-Amp Circuit Breaker (A11) on panel 4 ALPHA. The VHF 2 system is supplied with 28 VDC via a 10-Amp Circuit Breaker (D10) on panel 4 ALPHA.

VHF 1 and VHF 2 audio microphone and push-to-talk circuits are connected to the intercommunication system via connection strip 10 DELTA.

General specification data:

Power Supply	: 27.5 VDC
Current Draw	: 0.4 Amp (on reception) 7 Amp (on transmission).
Frequency range	: 118 to 135.975 MHz
Channel spacing	: 25 kHz
Frequency stability	: 0.0015 %.
Environment	: - 20°C to + 55°C (- 4°F to 131°F). 55000 ft (16764 m).

### **1.9.2 BA 1920 Passenger Interphone**

The BA 1920 auxiliary unit ensures the interphone for passengers in conference mode by means of the voice-operated switch, adjustable audio output using outside potentiometer, passenger system cut off from the crew system, (control available to the crew). It is installed with three pushbuttons for the passengers to call the crew members.

The BA 1920 system is powered with 28 VDC from TB 31 ICS junction box. The Passengers Address is powered with 28 VDC from panel 4 ALPHA via a 3-Amp circuit breaker (F18), or D9 (3A), or E2 (3A).

### 1.9.3 TEAM TB31 Inter-Communication System (ICS)

The ICS enables communication between crew members via the interphone in continuous conference with audio output volume adjustment possible, via press-to-talk control in case of faulty voice-operated switch, via an independent "CALL" channel, using the built-in pushbutton on the ICS volume switches.

Outside communication via on-board transceivers transmission channel: four radio channels, reception channels: ten adjustable channels (of which four associated with transmission channels) and one channels non-adjustable (eight adjustable channels can be provided if option is installed) according to version.

Communication between crew members and passengers via the auxiliary unit and a telephone, A "VIP Call" light on the instrument panel informs the crew members that the passengers wish to establish communication with them.

The system is powered from circuit breakers located on panel 4 ALPHA. Lighting is ensured by lighting power boards 49L and 50L.

Junction Box powered by aircraft 28 VDC power system; two separate lines. Current draw is approximately 100 mA. The Main Control Panel powered by aircraft 28V power system; two lines protected and filtered in the junction box and current draw is approximately 200 mA. Lighting is approximately 250 mA.

There was no difficulty in radio communication on VHF operating frequency and the intercommunication between passenger and pilot was found to be normal.

## 1.10 Aerodrome Information

Not applicable

## 1.11 Flight Recorders

1.11.1 The helicopter was equipped with Solid State Combination Cockpit Voice and Flight Data Recorder (SSCVFDR) model Honeywell AR-204C. The SSCVFDR is located on the rack at the left hand shelf behind the baggage compartment.

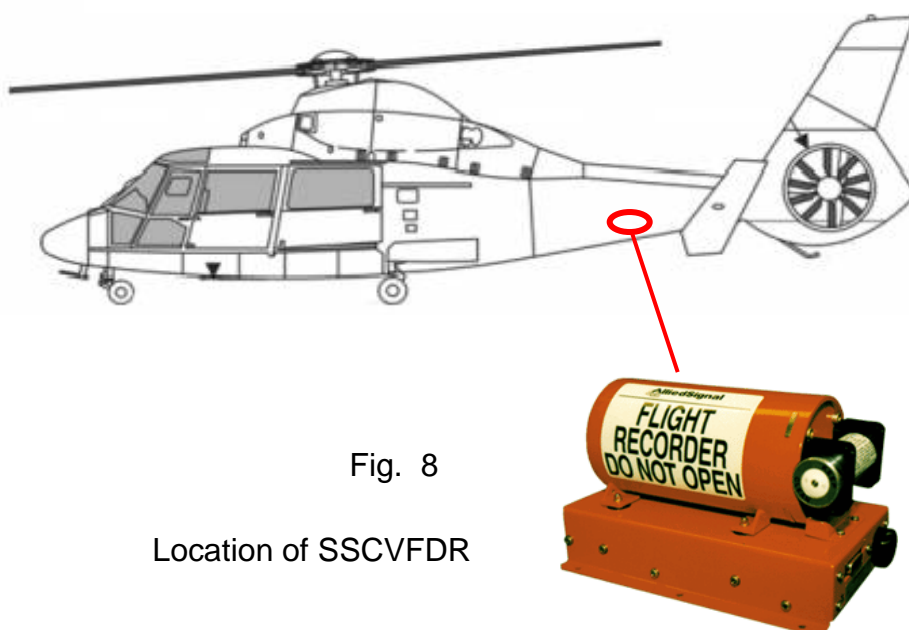

Fig. 8

Location of SSCVFDR

The voice recorder of this SSCVFDR has a recording capacity of at least 120 minutes (two hours) and capable of recording 3 crew channels and 1 area microphone channel. It keeps this audio in a solid state memory.

The flight data recorder of this SSCVFDR has a recording capacity to record 25 hours of flight data information at rate of 256 words per seconds.

1.11.2 Details of the SSCVFDR installed and specifications are as follows:

Manufacturer	: Honeywell
Model	: AR-204C
Part Number (P/N)	: 980-6021-066
Serial Number (S/N)	: 12129
Date last installed on aircraft	: 9 January 2015
Weight	: 4.2 Kg (9.2 lbs)

Power Supply	: 28VDC
Impact Shock	: 3400 G for 6.5 ms
Fire Temperature	: Max 1100°C (60 min)
Deep Sea Pressure and Sea Water Immersion	: 20,000 ft (30 days)

1.11.3 The SSCVFDR was equipped with underwater locator beacons (ULB) whose transmission time is at least 30 days, on the 37.5 kHz frequency, operating depth up to 20,000ft (6096 m) and activated with fresh or salt water immersion. The SSFDR was attached with a ULB as per below:

Manufacturer	: Dukane
Mode	: DK-120
S/N	: SD38654
ULB Expiry Date	: 30 June 2020

1.11.4 The SSCVFDR was recovered at the crash site approximately 18 hours after the accident. The SSCVFDR was hand carried by AAIB Malaysia personnel to Air Accidents Investigation Branch (AAIB) United Kingdom at Farnborough for the voice and data download on 7<sup>th</sup> April, 2015. Both voice (from 4 channels) and data (approximately more than 400 parameters) from the SSCVFDR were able to be downloaded and readable. Detail analysis of the voice and data recorders for each parameter is being carried out. Appendix 9 shows some of the parameters recorded by the flight data recorders approximately 65 seconds prior to the accident.

## **1.12 Wreckage and Impact Information**

1.12.1 The helicopter wreckage was destroyed by the impact forces and post-crash fire at the bottom of a ravine. The main gearbox (MGB) and both engines were found close to the main wreckage area. Some components of the helicopter including the fenestron, door, main rotor blade parts, cowlings, engine exhaust pipe, tail rotor drive shaft and horizontal stabilizer were found scattered around 200 - 300 meters from the main wreckage. The components were scattered along the trajectory of the helicopter. There was no evidence of the helicopter making contact with the terrain until it impacted the ground. See wreckage distribution chart in Appendix 4.

### **1.12.2 Engine Inspections.**

No. 1 Engine, Serial Number: 4270

An inspection on the Metal Chip Detector and the Electro Metal Chip Detector of the No. 1 Engine did not reveal any evidence of contaminants or



deposits of an abrupt engine failure. The oil filter appears normal and clean. The manufacturer's alignment marks which coupled the power transfer shaft to the spline at the reduction gearbox - Module 5 did not indicate of any signs of excessive engine over-torqued. Boroscope inspections around the impeller section revealed slight traces of aluminium deposits due to sudden scrapping under impact load. There was evidence of slight nicks on the compressor blades due to ingestion of debris. The compressor blades had totally seized. (See Appendix 5 Fig 11)

No. 2 Engine, Serial Number: 4272

An inspection on the Metal Chip Detector and the Electro Metal Chip Detector of the No. 2 Engine did not reveal any evidence of contaminants or deposits of an abrupt engine failure. There was no evidence of contaminants in the oil and fuel filters. Both these filters appear normal and clean. The manufacturer's alignment marks which coupled the power transfer shaft to the spline at the reduction gearbox - Module 5 did not indicate of any signs of excessive engine over-torqued.

The compressor blades were found jagged and severely bent due to foreign objects damage (FOD) from ingress of wooden branches. Boroscope inspections around the impeller section revealed traces of solidified aluminium deposits due to sudden scrapping under impact load and intense heat. The compressors were totally seized and there was evidence of post impact fire on the engine.(See Appendix 5, Fig 12)

#### 1.12.3 Main Rotor Hub and Main Rotor Blades.

All four main rotor blades had separated from the attachment of the main rotor head. One of the main rotor blades had evidence of severe damage on the main rotor tip. This would suggest that it could have struck the fenestron leading edge.

Two of the main rotor blades had evidence of red paint marks on the leading edges of the centre section of the main rotor blades. The fragments on the main rotor blades suggest that the damage could be attributed to high impact force with the tail boom structure and subsequent post impact damage after separation from the main rotor head. (See Appendix 5, Fig 12)

#### 1.12.4 Fenestron - Tail Rotor Section.

The examination on the fenestron revealed that extensive damage was caused by high impact force which caused it to separate from the tail boom structure.

The breakage of the tail rotor blades revealed that there was evidence of sudden impact against the fenestron casing whilst under high rotational speed. There were severe scrubbing marks on the internal side of the fenestron casing. The evidence of some cutting marks on the leading edge of the fenestron would indicate contact with the main rotor blades.( See Appendix 5, Fig 4 and 5)

## **1.13 Medical and Pathological Information.**

### **1.13.1 Evacuation and Identification of Remains.**

The total number of persons onboard the helicopter were 6, including the pilot. The bodies were recovered from the crash site and transferred to Kuala Lumpur General Hospital for identification purposes.

The identification of the bodies was performed by the Disaster Victim Identification Team which comprised of surgeons, forensic pathologists, forensic odontologists and DNA experts.

### **1.13.2 Injuries to victims.**

Based on the examinations of the deceased bodies, injuries were observed on their skulls, face, limbs and upper bodies. The nature of the injuries was consistent with injuries due to impact trauma and burns.

Autopsy performed on the bodies revealed no post-crash survival signs.

### **1.13.3 Aircraft Commander**

The body of the deceased showed evidence of being transected into 4 parts with multiple injuries and post-impact 80% charring of the body. There was no obvious evidence of heart disease. Toxicology for alcohol and common drugs of abuse was negative. The commander body was found at the front right seat where the right position of the aircraft commander.

### **1.13.4 Female Passengers**

The body of the deceased showed evidence of being transected into 3 main body parts consisting of the upper half of the body with charring on the left side, lower half of the body together with the left lower limb and the right lower limb. The deceased sustained multiple injuries with post-impact fire resulting in charring of some parts of the body. The body was found at the left of the commander where she was occupying the left front seat.

## **1.14 Fire**

There was extensive fire that consumed most of the components after impact.

## 1.15 Survival Aspects

The accident was non survivable.

## 1.16 Test and Research

There were two tests conducted during the investigation;

- a. Fluid Sample Test by Chemist Department Malaysia and
- b. Structure Detail Examinations by STRIDE (Science and Technology Research Institute for Defence).

The result of the test will allow the investigator to verify the fluid sample collected at Sekolah Kebangsaan Ladang Kota Bahagia (SKLBK) belongs to IGB and the detail structure examination will allow the investigator to determine the failure mode and pattern, and to verify the direction of the failure.

### 1.16.1 Fluid Sample Test

The helicopter made an unscheduled landing at SKLBK. While landing at the school field, the Left Hand (LH) Landing Gear sunk into the ground. The photo below shows the sunk hole on the ground due to the landing gear.

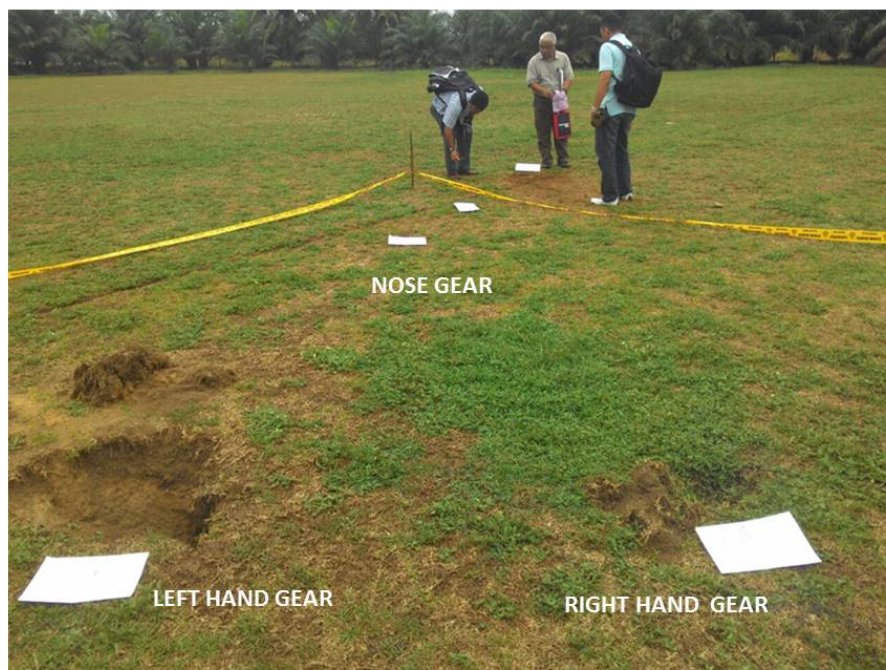

Fig 9

The traces of fluid from the sunken hole was collected and sent to the Chemist Department of Malaysia for detailed analysis. The sample fluid was traced to meet the Mobil Jet Oil II (Synthetic) specification. See figure 11.

The hydraulic liquid for the landing gear system is also used for the oleo strut and brake system.

The photos below show the oil traces on the field at Sekolah Kebangsaan Ladang Kota Bahagia.



Fig. 10

The traces of earth with oil sample was placed in a plastic bag and sent to Chemist Department of Malaysia for detailed analysis. See Fig. 11.

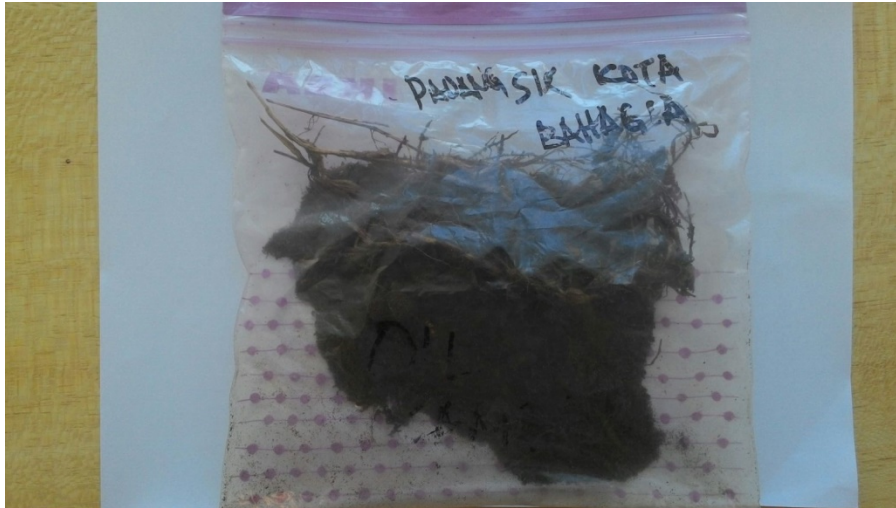

Fig. 11

Test result from the Chemistry Department of Malaysia shows that the sample taken at the SK Ladang Kota Bahagia is consistent with the Mobil Jet Oil II (Synthetic) of the AS365N3 helicopter hydraulic fluid specification.

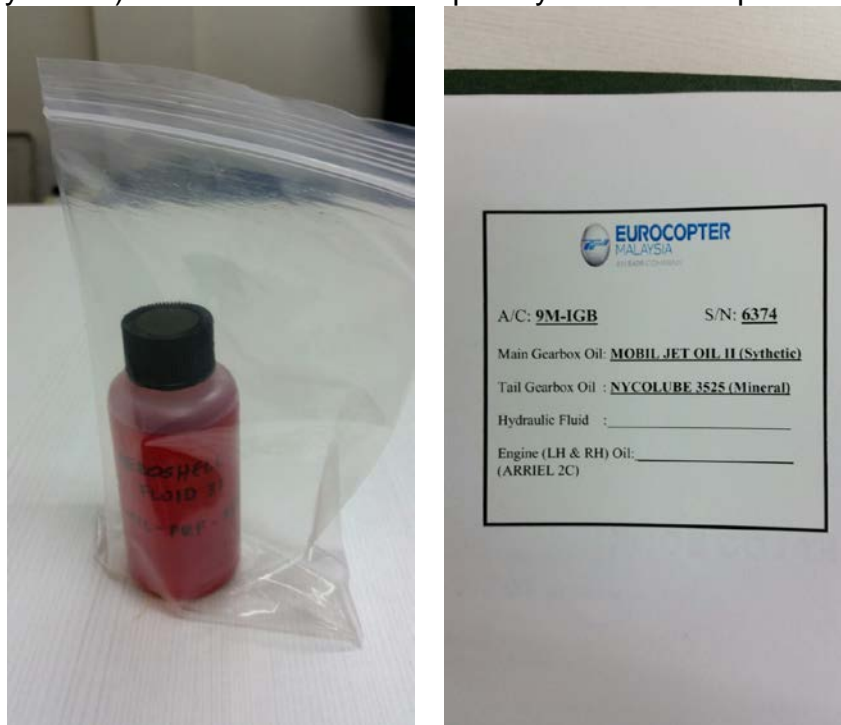

Fig. 12

The hydraulic fluid may indicate evidence of some leakage from the helicopter hydraulic system at the field where the aircraft landed.

#### 1.16.2 Detailed Structure Examination

- a. A piece of chipped-off paint

During subsequent visit to at SKLKB, the investigator found a piece of chipped-off paint which is similar to the colour of the helicopter leading edge of the horizontal stabiliser. ( Fig 13)

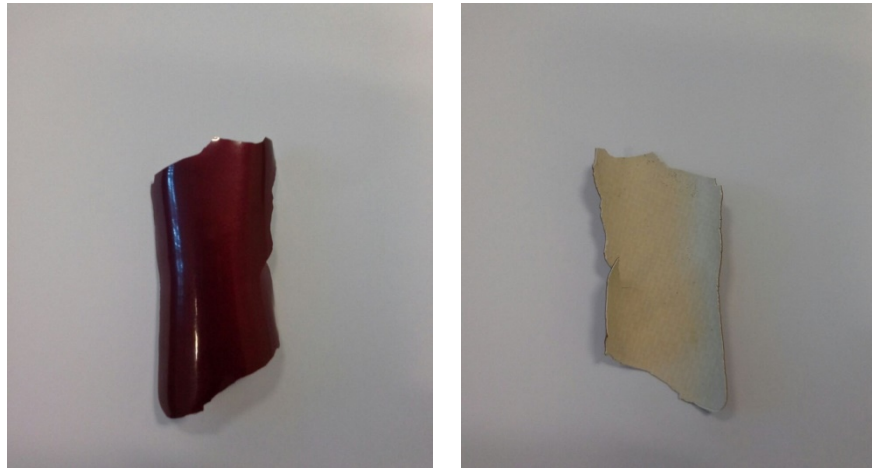

Fig. 13

The above photo shows the piece of chipped-off paint was sent to Chemist Department for analysis. There was no conclusive result obtained on the analysis of the piece of sample. Further test was carried out by matching the paint contents and feature from the chipped off part and the paint from the helicopter. The Left Hand Horizontal Stabilizer was missing; however, the RH Horizontal Stabiliser was found together with the wreckage and the piece of chipped-off paint matched the colour and countour of the aerodynamic profile of the horizontal stabiliser leading edge.

The piece of chipped-off paint sample could have been detached from the LH horizontal stabiliser leading edge. (See Fig 13)

#### b. The Horizontal Stabilizer

As the LH Landing Gear sunk into the ground, the vertical fin of the LH Horizontal Stabilizer had contacted the ground and may have caused premature structural damage to the LH Horizontal Stabiliser. The piece of chipped-off paint found on the field provides the evidence that LH Horizontal Stabiliser and helicopter structures has been badly distorted causing the dislodgement of the piece of paint.

The investigation was focussed on the LH Horizontal Stabilizer because it was suspected that the horizontal stabilizer had detached in flight before the helicopter lost control, and the section of the LH Horizontal Stabilizer had been missing from the wreckage site.

*STRIDE (Science and Technology Research Institute for Defence)* was requested by IIC as the technical experts to conduct a detailed structural assessment. The composite structure consists of laminated numbers of plies of fibres in numerous directions. Analysis of each ply failure will indicate the

primary direction of failures which will provide information on the direction of loads. The plies failure features shown in ICAO Doc 9756 is used as the guidance in determining the failure modes.

The following photo shows the fiber pullout resulted from tensile load on the structure.

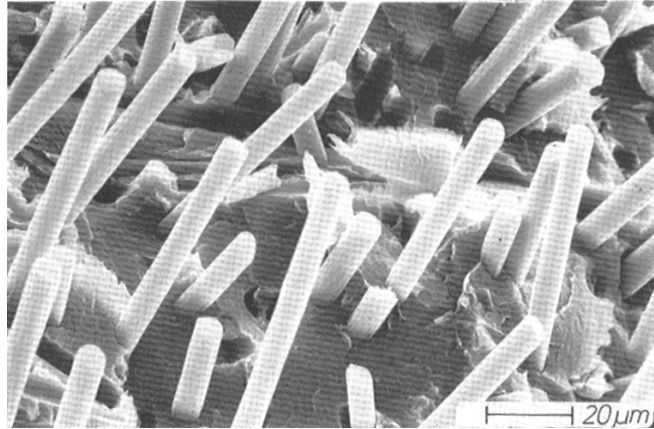

Fig 14

The kinking of fibers shown in FIG 15 indicate results of compressive loads on the structure, with some applied load translated into all the fibers. It also shows the kinking of fibers in the direction of compressive load.



Fig 15

The following photo shows there was evidence of chop marks on the ends of broken structure which indicate that the fibers had buckled and failed under compressive load as well.

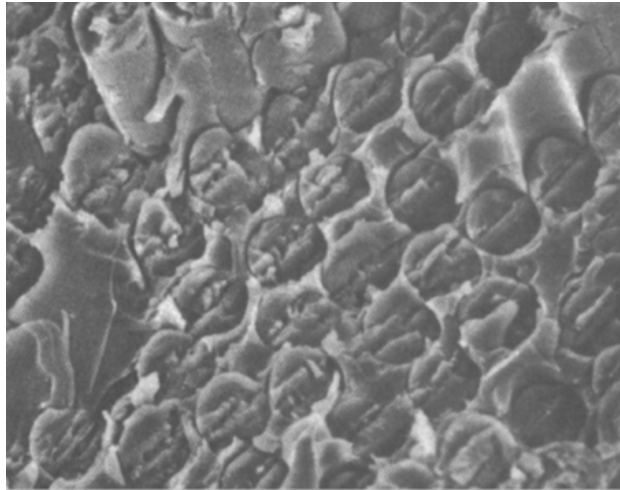

Fig 16

The following photo provides evidence of failure on the composite structure due to bending forces. See Fig. 16 – The relative rough area, visible strands of fibers and tension area and the smooth region as shown in photos indicate failure by compression.

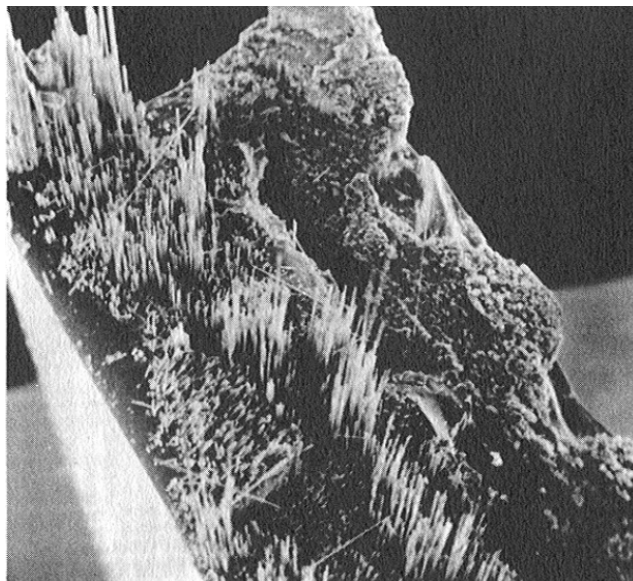

Fig 17

The following photos show the delamination between the composite plies which could attribute to pre or post impact.



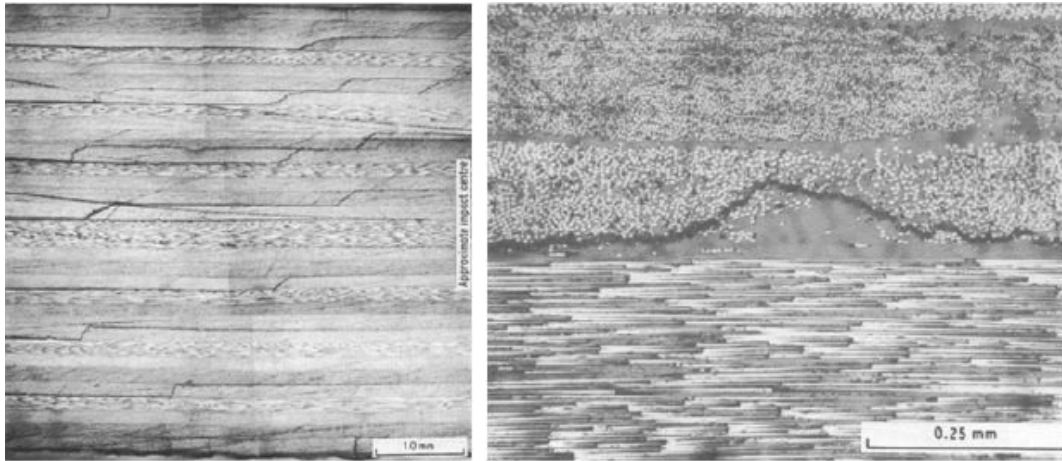

Fig 18

The AAIB and STRIDE team conducted the examinations in order to determine the failure characteristics.



Fig 19

The above photo shows the reconstruction of the horizontal stabilizer assembly. The Left Hand Horizontal Stabilizer was missing.

The technique of examining the composite plies failure is by loading modes on the structure. This technique is detailed in the ICAO Doc 9756. The examination of the plies under the ESM will provide accurate indication of the plies' failures. However, the ESM technique was not carried out. Only a thorough visual examination was carried out.

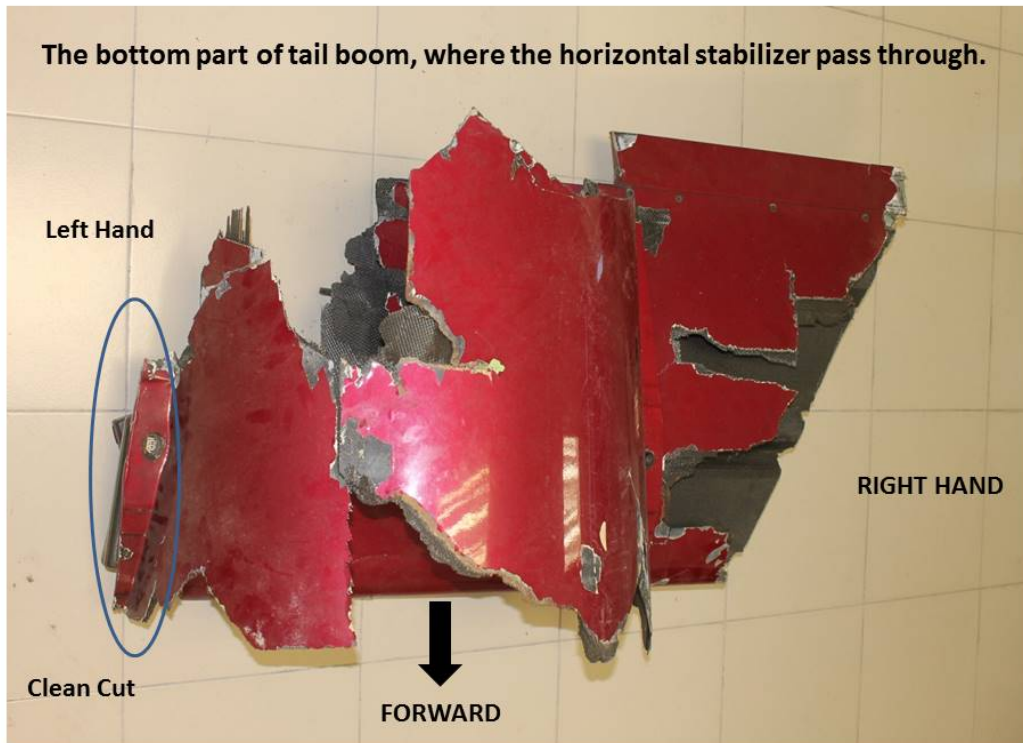

Fig 20

The tail boom section was reconstructed and each failure point was examined. The above photo shows the failure of the tail boom and part of the horizontal stabilizer were reconstructed.

The tail boom section was examined in detailed and the failure points show a clear cut on the tail boom skin parallel to the helicopter longitudinal axis, as shown. (See Fig 20 and Fig 21)



Fig 21

A straight line failure may indicate failure due to compression load. A detailed closed up examination had shown a clean cut failure in a straight line direction (See Fig 22).



Fig 22

The examination continued with the section of the horizontal stabilizer. As the tail boom section is removed, the horizontal stabilizer section at the breaking point is visible as shown in Fig 23.

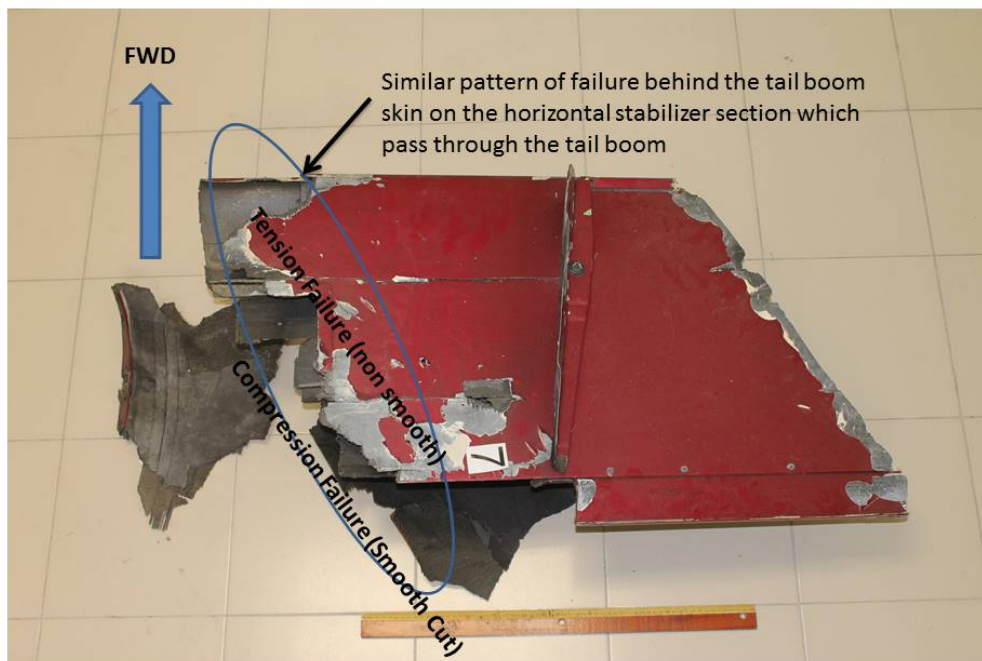

Fig 23

The top skin of the horizontal stabilizer had smooth cut which indicates it had failed under compression load whilst the bottom skin of the horizontal stabilizer had jagged edges failed under tension load. (See Fig 24)



Fig 24

The tail boom attachment to the horizontal stabilizer indicates a pulled through failure. A review the structure failure lines is shown in the following diagram (See Fig 25).

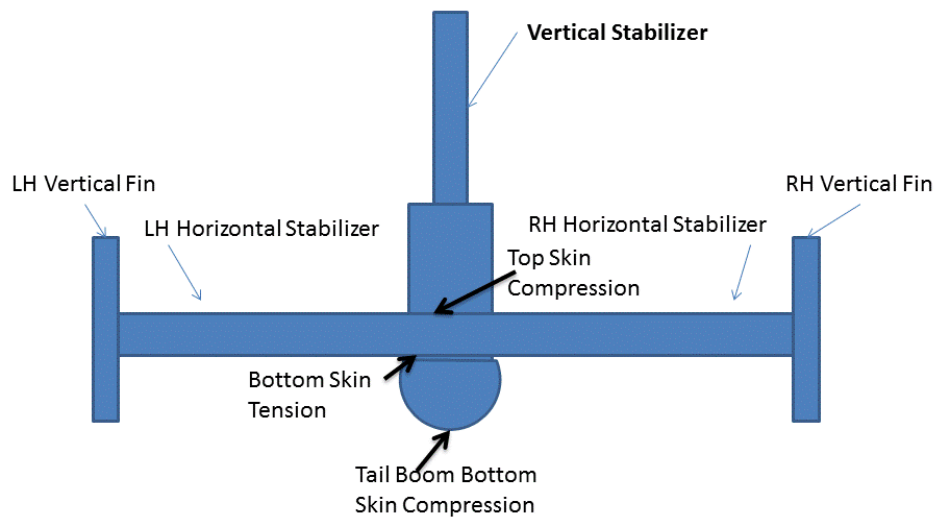

VIEW LOOKING FORWARD

Fig. 25

If we consider the down load force, the LH Horizontal Stabilizer will bend downward which will result on the top skin under tension and bottom skin under compression. However, the examination on the structure of the bottom

skin of the tail boom appears consistent with the failure mode of the LH Horizontal Stabilizer bending downward as evidence from the clean fracture line along the tail boom. (See Fig. 25)

The inconsistency on the LH Horizontal Stabilizer failure pattern showing the top skin under compression and bottom skin under tension might suggest that there could be a premature failure on the LH Horizontal Stabiliser structure as the vertical fin hit the ground when the helicopter landed and the LH Landing Gear subsequently sunk into the ground at SKLKB. As the LH vertical fin hit the ground, the LH Horizontal Stabilizer will bend upwards and will hinge at the mid span of the LH Horizontal Stabilizer as shown by the failure line parallel to the tailboom attachment.

The section of the tail boom remain attached after the LH Horizontal Stabilizer was separated at the initiation of failure point, near the attachment of the tail boom and the LH Horizontal Stabilizer.

### **1.17 Organisational and Management Information**

1. 17.1 Aircraft Owner : Orion Corridor Sdn Bhd.  
Level 32, The Gardens South Tower  
Mid Valley City  
Lingkar Syed Putra  
59200 Kuala Lumpur.  
Malaysia.

1.17.2 Ground Handling Services : Chempaka Helicopter Corporation Sdn Bhd  
Solaire Hangar, Skypark Terminal  
Sultan Abdul Aziz Shah Airport  
47200 Subang, Selangor  
Malaysia

1.17.3 Orion Corridor Sdn. Bhd.

Orion Corridor Sdn. Bhd was the registered owner of IGB and the pilot who flew on the day of the accident was one of the directors of the company. The pilot was also the director of Solaire Sdn. Bhd and Chempaka Helicopter Corporation Sdn. Bhd. The Solaire Sdn. Bhd. was the sales agent for Robinson helicopter in Malaysia. It has credit facility with Petronas for refuelling at all Malaysian Airports.

The Cempaka Helicopter Corporation Sdn. Bhd. was the AOC holder for non-schedule operator of R22 and R66 helicopters. There was a contract signed on 20<sup>th</sup> June, 2012 for the 9M-IGB helicopter to operate under Cempaka Helicopter Sdn. Bhd. for Public Transport operations. However, the helicopter was still under Private Category Certificate of Airworthiness and has not been included in the AOC, Operations Specification until the accident occurred. All previous flights prior to the accident were carried out under

Private flights. The investigation was not able to determine if any reward had been paid or promised for the conduct of those flights.

Cempaka Helicopter Sdn Bhd has been providing hangarage for IGB and assisted its operations in terms of ground handling, flight planning, flight following and refuelling.

## **1.18 Additional Information**

### **1.18.1 Stabilizers – Never Exceed Speed (VNE) and Rate of Descent (R/D) Limitations.**

Airbus Helicopters had issued a Service Bulletin No: AS365-55.00.06 dated 14<sup>th</sup> November, 2014 on Stabilizer – Horizontal Stabilizer – Upgrading of Stabilizer installation for suppression of the flutter phenomenon by addition of material offering damping characteristics which could eliminate the dynamic coupling between torsion and bending on the horizontal stabiliser.

EASA Airworthiness Directives AD No.: 2008-0204R1 dated 21<sup>st</sup> May, 2014 has made it mandatory for compliance to SA 365N, SA 365 N1, AS365N2 and AS365N3 helicopters due to some reports of failed horizontal stabilizers on AS 365 N3 during acceptance test and training flights as part of the demonstration of the never-exceed speed (VNE) and resulted into in-flight separation and loss of the failed sections.

The test results revealed that the reported incidents were caused by a vibration phenomenon that may have been generated during descent flight phases at high speed, regardless of the stabilizer part number.

The EASA AD has imposed VNE limitation to all SA 365 N and AS 365 N helicopters, regardless of part number of installed horizontal stabilizer an implementation of a – 1,500 ft/min Rate of Descent (R/D) limitation beyond 140 knots Indicated Air Speed (IAS).

The result of flying with all 3 landing gears in the extended position beyond the 140 knots Indicated Air Speed would create a severe aerodynamic drag and undue stresses on the horizontal stabilizer due to its inverted camber structure and it may exceed its structural limitations.

## 1.19 Useful or Effective Investigation Techniques

### 1.19.1 Spectrum analysis audio data

The audio files *CAM 0124 to 012520.wav*, *Ch1 0124 to 012520.wav* and *Ch2 0124 to 012520.wav* contain the beginning of the flight, at the engine power up. At this moment, the acoustic signature of this helicopter did not show any particular anomalies compared to the spectrum normally observed on the AS365 helicopter family.

The audio files *CAM 0133 to 0137.wav*, *Ch1 0133 to 0137.wav* and *Ch2 0133 to 0137wav* contain the landing of the helicopter in a non-aeronautical field. During this landing, an impulse<sup>1</sup> noise was recorded on the CAM track at 08 h 20 min 32 s 400. This impulse noise immediately followed with a reaction of surprise from the pilot. Just after that noise, the rotation frequency of MGB rotating parts showed sudden variations with a high amplitude (see Appendix 8, Fig 1). During those variations, several warnings were triggered.

The audio files *CAM last minute.wav*, *Ch1 last minute.wav* and *Ch2 last minute .wav* contain the last minute of respectively CAM, Channel 1 and channel 2 recordings. The spectrum view in Appendix 8, Fig 3 showed several acoustic signatures (harmonic families) typical of the helicopter propulsion system spectrum:

The acoustic signature associated with Main Rotor blade rotation with a fundamental frequency of 23.66 Hz (BR – Blade Rate).

The acoustic signature associated with Tail Rotor drive shaft with a fundamental frequency of 1085 Hz.

The acoustic signature associated with MGB input meshing rotation with a fundamental frequency of 2740 Hz.

These fundamental frequency values indicate that the propulsion system was at 100% of its nominal rate (confirmed by FDR data, see Appendix 8, Fig 1). The propulsion system condition appeared to be nominal until 3.3 seconds before the end of recordings. At that moment, a transient noise was recorded on the CVR. It was not possible to determine the nature and the origin of that noise. 0.5 seconds after that noise (i.e. 2.8 s before end of recordings), the spectral lines associated with the helicopter propulsion system disappeared. This disappearance coincided with the appearance of a high energy level phenomenon. That phenomenon was made up of multiple acoustic events similar to impact noises (see Appendix 8, Fig 2). Several warnings were triggered during that phenomenon. The interval between each impact is a multiple of the main rotor shaft rate, which allows asserting that the impacts recorded are main rotor blades collision with an external unknown item. The measure of impacts intervals at the *High NR* warning triggering indicated that the main rotor speed was 8% (i.e. 108.4 %) above its nominal speed rate, which was consistent with FDR data. However, the limitation of acoustic analysis made it impossible to describe the impacts sequence. Other

frequency information related to the propulsion system and to acoustic events occurrences are included in Appendices.

#### 1.19.2. Transcription

A transcription of the provided audio samples was performed (see Appendix 3). The contents of this transcription showed that during the landing phase, a loud “thud” noise was recorded on the pilot track. This noise corresponded to the vocal exclamation of the pilot consecutive to the left landing gear sinking in the soft ground in the open field. The pilot was firstly wondering if the landing gear was collapsing or not. The female passenger indicated to him that the “wheel went into the ground”.

#### 1.19.3. Flight parameters - data quality

Accelerations parameters are of good quality. The A/P related parameters are not available most probably because of the failure of the converter that transmitted the information to the PFD and to the FDR. The hands-off and A/P warning parameters were taken into account. The flight commands motion was consistent with A/P activity.



## **2. ANALYSIS**

### **2.1 Introduction**

The fatal helicopter was seen making a steep dive by another pilot flying EC 155 in the vicinity. It was seen diving steeply to the ground shortly after making radio contact in order to maintain a safe separation. It impacted the ground overgrown by rubber trees almost vertically and caught fire followed with black smoke.

Upon examination of the wreckage it was found that the LH horizontal stabiliser was missing. An extensive search for the missing LH horizontal stabiliser was carried out without any success. A detailed mathematical calculations for the approximate drop location of the stabiliser was also done with the assistance of the manufacturer. Several attempts to search the missing LH horizontal stabiliser with the assistance of the police and military personnel were carried out on ground and a search from the air using R66 helicopter was also carried out without any success. The tail empennage to which the left stabiliser attached was recovered not within the wreckage and believed to have been consumed by fire. However the remaining RH horizontal stabiliser was found near the main wreckage.

An analysis of the SSCVFDR carried out at the manufacturer's facility revealed that the behavior of the helicopter seconds before the dive was consistent with the LH horizontal stabiliser detached in flight. The recorder also revealed that when the helicopter landed at the last landing point, the Left Hand Main Wheel had sunk into loose soil of approximately 20 inches depth, causing the helicopter to tilt to the left for approximately 13 degrees. The sudden sinking of the Left Hand Main Wheel and tilting would have caused the LH horizontal stabiliser vertical fin to hit the ground and causing some damage to the inboard root of the Left Hand horizontal stabiliser. The extent of damage was still undetermined and was not detected by the pilot. Mathematical calculations on the depth of the wheel sunk into the soft ground indicated that the horizontal stabiliser could have bent upward at the root by approximately 45mm. Since the horizontal stabiliser was made of composite structure, the stress at the damaged area would weaken the structure of the LH horizontal stabiliser and would induce more stress and damage during the flight without significant vibrations, leading to a complete failure and detachment of the LH horizontal stabiliser in flight.

The evidence of excessive hydraulic fluid found around the landing area on the fields at Sekolah Kebangsaan Ladang Kota Bahagia would indicate possible lost of hydraulic fluid from the stressed oleo strut of the LH Main Landing Gear due to its abrupt inclination into the ground and possible damage to the LH Main Wheel hydraulic brake lines. Knowing that the undercarriage was damaged the pilot decided to continue the flight to the destination with all three landing gears remained in the extended down position. The most likely reason to press on for the flight was to accommodate the passenger request to arrive at the destination without delay and to enable him to attend the formal dinner as planned.

It was noted shortly before the accident, the helicopter was cruising at 146 Kts and at an altitude of 1700 feet with a rate of descend of 400 feet per minute with the three landing gears remained in the extended down position.

EASA had issued AD Airworthiness Directives AD No.: 2008-0204R1 dated 21<sup>st</sup> May, 2014 to impose VNE limitation to all SA 365 N and AS 365 N helicopters, regardless of part number of installed horizontal stabilizer an implementation of a – 1,500 ft/min Rate of Descent (R/D) limitation beyond 140 knots Indicated Air Speed (IAS). The result of flying with all three landing gears in the extended position beyond the 140 knots Indicated Air Speed would nevertheless create a severe aerodynamic drag and load on the weaken structure of LH horizontal stabilizer. This could contribute to the separation of the LH horizontal stabiliser in flight.

An analysis of the SSCVFDR revealed that 2.5 seconds prior to the steep dive, the LH horizontal stabiliser could have detached from the helicopter. While flying on Autopilot with ALT upper mode engaged on pitch axis, the helicopter subsequently pitched down to 52 degrees and roll to the right 70 degrees. At about this time, the pilot took action on the cyclic stick, but the helicopter was already in a state of unusual attitude which cannot be recovered. The main rotor blades under the extreme load factor impacted the helicopter structure which caused extensive damage to the fuselage and severed the tail fenestron. The helicopter became out of control and dropping steeply without any effect on pilot recovery action.

A detailed examination of the wreckage and damages on the main dynamic components such as the Main Rotor Head, Main Gearbox, Engines, Tail Rotor Transmission Shafts, Tail Gearbox, Tail Rotor Head and the flight controls had attributed to the initial impact by the Main Rotor Blades hitting the cowling, tail boom and the fenestron, and the consequences of terrain impacts with high rotational power and torque.

The location of the first Main Rotor Blade impact on the fenestron leading edge indicates that the Main Gear Box suspension was normal and correctly connected to the airframe when the accident occurred.( See Appendix 6)

The inspection on the Metal Chip Detector and the Electro Metal Chip Detector of the No. 1 Engine and No. 2 Engine respectively did not reveal any evidence of contaminants or deposits of an abrupt engine failures. The oil filter appears normal and clean. The manufacturer's alignment marks which coupled the power transfer shaft to the spline at the reduction gearbox - Module 5 did not indicate of any signs of excessive engine over-torqued.

A review of the past aircraft history from the aircraft log books on Event 1, 2 and 3 by Airbus Helicopter Malaysia revealed that it had been thoroughly inspected and supported by AH experts at the 5400 hours inspection and conversion to N3. The investigation had revealed that the aircraft including the tail boom had been dismantled and the airframe paint had been removed to give full visual access to the sub-assemblies. The vertical fins of the

horizontal stabilizer were exchanged with new ones. The rest of the stabilizer was removed and sanded down, inspected and reinstalled as it met the inspection and validation criteria. Airbus Helicopter Malaysia stated that there was no reason to consider any horizontal stabilizer damage in the aircraft history before the 2012 release to service was an underlying cause to the failure on the accident day. The long period of inactivity of this helicopter was due to a combination of causes ranging from financial issues and on storage awaiting prospective customers. The use of the helicopter for training purpose at AH Malaysia had made the completion of the work packages longer period than usual. On 09 February 2012 at 5,900 airframe hours, Airbus Helicopters Malaysia returned the helicopter status to "Available for flight" which made it airworthy for flight. On 15 March 2012, it was put in service under Orion Corridor Sdn Bhd as the new owner.

Based on the above information and due to the lack of hard evidence to substantiate the actual condition of the LH horizontal stabiliser, the use of the SSCVFDR information was thoroughly analysed. The SSCVFDR recovered from the wreckage was in good condition and brought to UK AAIB for downloading. The recorded information on voice and flight data were in good condition and that information was shared with manufacturer and BEA for analysis. The recorded information would enable the investigation to focus on possible failure of the LH horizontal stabiliser in flight and the element of human factors of the flight crew.

## **2.2 Commander's (Pilot) experience and qualifications**

The commander is a citizen of the United States of America with date of birth on 29<sup>th</sup> March, 1968. His height is 71 inches and weighing 205 kilogram. He possessed Malaysian and FAA commercial pilot licenses.

Based on the medical history, autopsy findings and toxicology test, there were no evidence to indicate that the pilot's performance was affected by physiological factors.

## **2.3 Female passenger**

She was 25 years old and a Kyrgyztan citizenship. She came to Malaysia in mid-2009 and studied at Sunway College, Subang Jaya from July 2009 until February 2010 on pre-university matriculation. She then went on to Lim Kok Wing University majoring in Foundation of Business (FB) from February 2010 until May 2010 but did not complete her studies there. In September 2013 until November 2013, she furthers her studies at SEGI College Kuala Lumpur for a degree in business studies. But after three months, her study was terminated by the college due to her student visa was not approved by the Immigration Department.

She was a friend of the pilot and had been seen together at the airport and sometimes following the flight. Witness statement revealed that she had

done a medical checkup at an approved Designated Medical Examiner clinic to prepare herself for a formal flight training.

Her familiarity using the helicopter intercom system and her observation on the landing gear position and operations revealed that she had been in the helicopter cockpit on several occasions. She did not possess any flying license during the fatal flight. The AS 365 N3 helicopter flight manual requires a minimum of one pilot for operations.

#### **2.4 The landing and take off from the open field (last landing point)**

The selected area for landing was about the size of 3 football field and the approach path was considerably easy and safe for AS365 N3 to land. Instead of landing in the middle of the field, the pilot opted to land towards the extreme forward edge of the field. The chosen area for the landing was covered by grass and the view from the cockpit did not allow the pilot to assess the ground condition accurately.

At 1620 LT (7 minutes after taking off from Muazzam Shah) the helicopter landed on the field at Sekolah Kebangsaan Ladang Kota Bahagia to offload one of the passengers. As the wheel touch the ground and collective lever reduced to 22%, the LH landing gear sunk into loose sandy ground. Subsequently, the helicopter tilted to the left up to 13.36 degrees inclination. The helicopter remain steady in this position for duration of 6.6 seconds. At this juncture a loud 'thud' noise was heard in the intercomm system and raised concern by the passenger and the pilot. The helicopter was brought to hover and repositioned 10 meters forward of the landing point and remained on ground for 3 minutes with the rotors running. Based on mathematical computation by Airbus Helicopters, it showed that the LH horizontal stabiliser structure was damaged without the knowledge of the pilot or any of the passengers. The excessive hydraulic fluid found in the hole made by the left landing gear did not trigger any hydraulic warning light during the take off check performed by the pilot. ( See Appendix 12)

Analysis of the CAM track revealed that the loud 'thud' noise recorded during the landing had a noise level high enough to trigger the microphone treshold.

The helicopter took off from the open field at 1625 LT after offloading one passenger and flew to the direction of Subang (Mines)

## Horizontal stabilizer Resistance

- The horizontal stabilizer begins to damage for a vertical load at its extremity of 160daN.  
( $\ll$  Fleft\_mlg = 1874 daN when outboard tail fin contacts the ground)
- Under  $F_z=160\text{daN}$  the horizontal stabilizer bent of 45mm.  
( $\ll$  237mm when the Left landing gear is in the soil of 40cm)

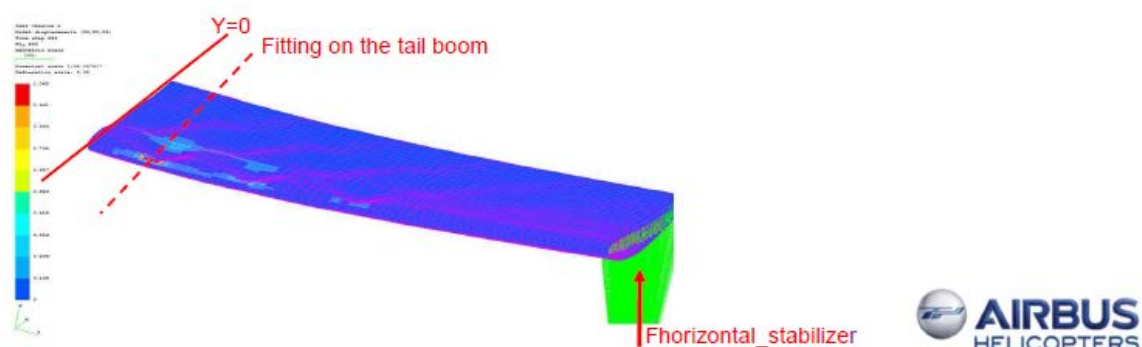

Fig.27

### 2.5 Stabiliser effect on aerodynamic

When the helicopter was cruising at high speed, at 148 knots, the helicopter was in nose down attitude. The nose down attitude to be corrected by the negative lift force generated by the horizontal stabilizer for a comfortable flight. The aerodynamic load on the horizontal stabiliser varies with helicopter mass, forward speed, and the altitude flown. At this condition, the horizontal stabilizer will experience high moment loading. Since the horizontal stabilizer was already damaged, this aerodynamic load would cause the horizontal stabilizer to separate from the helicopter. The configuration during this flight was reasonably high All Up Weight, high forward speed, 400 feet Rate of Descend compounded by landing gear in the down position, the sudden loss of the horizontal stabiliser will create a abrupt pitch down moment. Due to that sudden pitch down movement, the helicopter can exceed its flight envelop if the movement is not counteracted by quick pilot action. In this case, the pilot had reacted on the cyclic 2.5 seconds after suspected loss of horizontal stabiliser which was too late. The main rotor blades impacted the airframe at approximately one second after loss of the left horizontal stabiliser. (Refer to Appendix 13)

## 2.6 A piece of chipped-off paint found at the last landing point

A small chip of paint was found at the last landing field on the second visit by the investigation team. The chip was curved in nature and having the colour of the horizontal stabiliser on the outer and white colour with cross grain in the inside. This paint chip most probably came from the missing left horizontal stabiliser because the right stabiliser was found intact. When the critical area of the leading edge was subjected to bending, and when the outboard fin contacted the ground, the critical area experienced compressive stress to buckling. In these conditions, delamination and failure of fibres on one of several plies can occur causing it to buckle. The paint could have chipped off from the left stabiliser which had been weakened by the bending stress. (See Fig 28 and Fig 30)

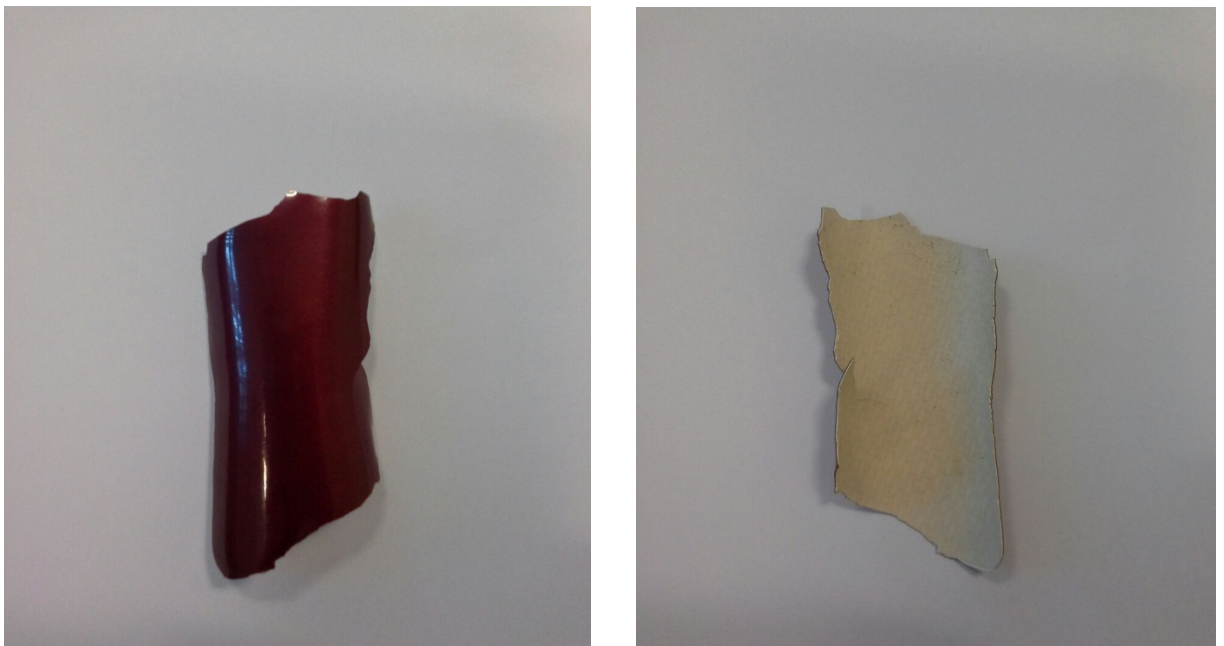

Fig 28

## 2.7 The final disintegration

Analysis of the FDR revealed that at 08 h 53 min 57.800s, the longitudinal acceleration decreased from 0.02 g to -0.11g. At that moment, a transient noise was recorded on the audio file. The pitch was  $-4.2^\circ$  and started to decrease.

500 ms after that transient noise, a high energy level phenomenon, similar to a succession of impacts was recorded. At that moment, the helicopter began a right roll.

The pitch decreased to  $-56^\circ$  within 1.5 s and the helicopter began a right roll. The crew had reacted only 2.3 sec before the end of the recordings. At this moment, the helicopter was already beyond the flight envelope.

The recordings ended at 08 h 54 min 01.330 s probably when the G-Switch triggered. Triggering of the G-switch should occur between 6g and 8g. (See See Appendix 6)



Fig. 29



Fig 30

## **2.8 Engine recorder parameters**

There was a sudden change in engine parameters in the last 3 seconds of recording with sudden drop of Torque down to zero, Increase of Power Turbine speed, NR increase beyond the Power Turbine speed, reduction of Gas Generator speed, Gas Generator speed still high (> 70%)

Corresponds to the engine control unit (DECU) reacting to the Power Turbine speed increase due to the a typical flight conditions

2.8.1 Loss of automatic control by DECU only in the final second of recording

2.8.2 Erratic values in the final second of recording corresponds to the final moment of the crash. Nominal engine parameters during the final flight and sudden changes in engines' parameters in last 3 seconds of recording when the DECU reacts to a typical flight conditions. Loss of automatic engine control only in the final seconds of recording. Examination on the engines and FDR data correlate the engines were running normally until the event in the last 3 seconds of recording. The engines were under automatic control until the crash (See Appendix 9 Fig 1)

## **2.9 Operations under private flight**

2.9.1 Sub Paragraph 2(4) of the Civil Aviation Regulation 1996 defines public transport as follows;

Subject to this regulation, an aircraft in flight shall for the purposes of these Regulations be deemed to fly for the purpose of public transport if in relation to such aircraft-

(a) hire or reward is given or promised for the carriage of passengers or cargo;

(b) any passenger or cargo is carried gratuitously by an air transport undertaking, not being-

(i) a person in the employment of the undertaking, including, in the case of a body corporate, any of its directors;

(ii) a person who with the authority of the Director General is making any inspection or witnessing any training, practice or test for the purposes of these Regulations; or

(iii) cargo intended to be used by any such passenger as aforesaid, or by undertaking; or

(c) for the purposes of Part V, hire or reward is given or promised for the right to fly the aircraft on that flight, not being a single-seater aircraft of which the authorised maximum total weight does not exceed 910 kilogrammes and in respect of which a certificate of airworthiness of the Special Category is in



force, otherwise than under a hire-purchase agreement; and the expression "public transport of passengers" shall be construed accordingly: Provided that, notwithstanding that an aircraft may be flying for the purpose of public transport by reason of paragraph (c), it shall not be deemed to be flying for the purpose of the public transport of passengers unless hire or reward is given or is promised for the carriage of those passengers: Provided further that a glider shall not be deemed to fly for the purpose of public transport for the purposes of Part V by virtue of paragraph (c) if the hire or reward given or promised for the primary purpose of conferring on a particular person the right to fly the glider on that flight is given or promised by a member of a flying club and the glider is owned or operated by that flying club.

Where under a transaction effected by or on behalf of a member of an unincorporated association of persons on the one hand and an incorporated association of persons or any member thereof on the other hand, a person is carried in, or is given the right to fly, an aircraft in such circumstances that hire or reward would be deemed to be given or promised if the transaction were effected otherwise than as aforesaid, hire or reward, shall, for the purposes of these Regulations, be deemed to be given or promised.

The expression "pilot" in these Regulations or the Schedules thereto shall mean the holder of a Commercial or Airline Transport Pilot's licence.

Any reference in these Regulations to a numbered regulation or Schedule shall be construed as a reference to the regulation or Schedule bearing that number in these Regulations.

However Civil Aviation Regulation 1996 also define air transport undertaking as;

***"air transport undertaking"*** means an undertaking whose business includes the carriage by air of passengers, cargo or mail for hire or reward;

2.9.2 Since the investigation was not able to determine any hire or reward was given or promised for the fatal flight, this flight was carried out in accordance to the CAR 1996 as a private flight.

## **2.10 Pilots licence**

The pilot was the holder of Malaysian Commercial Pilot Licence number 2762 (helicopter). His last medical examination was done on the 25 March 2015, however his licence validity on his CPL was from 5<sup>th</sup> April 2015 until 30<sup>th</sup> September 2015. His commercial pilot licence was valid for the flight.

On his aircraft rating (B) under group 1, there was an endorsement for AS 365 N3 dated 7 March, 2012. However there was no licence validity certificate indicating the expiry date of PPL privileges in his CPL.

## **2.11 Authority on the flight deck**

The flight was on Private Flight whereby the passengers were the guest of the Prime Minister of Malaysia to attend his daughter's wedding. The most senior passenger was the former Minister and Advisor to the Prime Minister's Department. He has been using the helicopter on several occasions especially visiting his constituency in Rompin.

During the flight from Pekan to Subang, the most senior passenger was consistently in communication with the pilot through the Aircraft Intercommunication System. An analysis of the communication from the CVR revealed that the pilot was well known to him. On several occasions during the flight, he insisted on the pilot to fly to KL instead of flying to Bandar Tun Razak. His insistence could have influenced the pilot's decision to rush the flight even though the pilot was aware of the serious hydraulic leakage on the LH landing gear.

## **2.12 Maintenance**

There was a maintenance contract between Onion Corridor Sdn Bhd (owner) and Airbus Helicopter but had expired. Upon further investigation, Airbus Helicopter admitted that on the day of the helicopter departure on 2<sup>nd</sup> April 2015 from Subang, the helicopter Daily Inspection was carried out by one of the Airbus Helicopter Licensed Engineers. The inspection was conducted based on purchase order from Onion Corridor Sdn Bhd. Subsequently, the Daily Inspection was carried out by the pilot himself under authorization issued by Airbus Helicopter through a Letter of Authorization at Appendix 11.

There was no abnormality on the maintenance program of IGB helicopter.

## **2.13 Recent similar accidents**

2.13.1 One case reported on AS365 N in 1999, Norway. - Rupture in flight of both sides of the horizontal stabilizer further to an excessive aerodynamic disturbance in flight well in excess of its flight and certification envelope. AAIBN accident investigation reported available on the website, describing the circumstances and consequence of this event (25 to 45% pitch down with firstly left followed by right roll effect = pilot attentive able to react immediately to counteract the aircraft attitude)

Note:

No corrective action was taken in relation to this case. It was considered as significantly out of flight envelope. Additional tests were performed in Airbus Helicopter laboratory)

### 2.13.2 Flutter phenomenon: -

4 cases reported on AS365 N3 in 2006 (AH)

- a. Loss in flight of the L/H side of the horizontal stabilizer during a reception flight to demonstrate de VNE. AS 365 N3 in 2008 (AH):
- b. Loss in flight of the R/H side of the horizontal stabilizer during a training flight. AS 365N3 in 2008 (AH):
- c. Loss in flight of the L/H side of the horizontal stabilizer during an acceptance flight. AS 365 N3 in 2008 (AH): Damage of the horizontal stabilizer discovery on ground during maintenance after a reception flight to demonstrate de VNE.

Loss of the horizontal stabilizer due to flutter.

Conservative measures: Issuing of an EASB (Emergency Alert Service Bulletin) 01.00.60 dated 06/2008: Limitation of the VNE to 150 kt. Issuing of EASB 01.00.60 Revision 1 dated 11/2008: To add a – 1500 ft/mn rate of descent (R/D) limitation beyond 140 kt.

Corrective measures: Issuing of the SB (Service Bulletin) 55.00.06 dated 11/2014: Introduction of the modification 07.55B28 to suppress the Flutter phenomenon. Issuing of EASB 01.00.60 Revision 2 dated 09/2014: Cancel the flight limitation (VNE and R/D) after application of ASB 55.00.06.

- d. Accidental damages: AS 365 N3 in 2014 - rupture due to a contact of the horizontal stabilizer fin with the ground while the aircraft was landing on snow covered terrain). SHK accident investigation report available on the website describing the circumstances and consequence of this event

This accident had some similarity with the accident of IGB. The air ambulance AS365 N3 landed lightly in snow surface at remote location to pick up a man after a snow mobile accident. The LH wheel penetrated the snow so much that the roll angle was more than 10 degrees. The LH fin hit the snow/ground and was bent to a higher position. The helicopter took off and after 200-300 meters of flight it got into unstable pitch. The speed was reduced and it was noticed that half of the stabiliser and and left hand fin was missing.

## 2.14 Simulation on lost of horizontal stabiliser in flight

### Simulation initial conditions

- The helicopter is trimmed à 146.25 kts, descent at 400 ft/min (corresponding to time  $t=4.375$  seconds before the reference time)
- Weight is 3300 kg and CG is 5 cm forward (these parameters shall have to be updated as soon as we get more data)
- Computation is performed at sea level ISA
- The control position measured in flight are considered by the simulation tool from  $t=4.375$  seconds before the reference time.
- Thanks to the simulation tool, we can start the « loss of left stabilizer » event at any time.

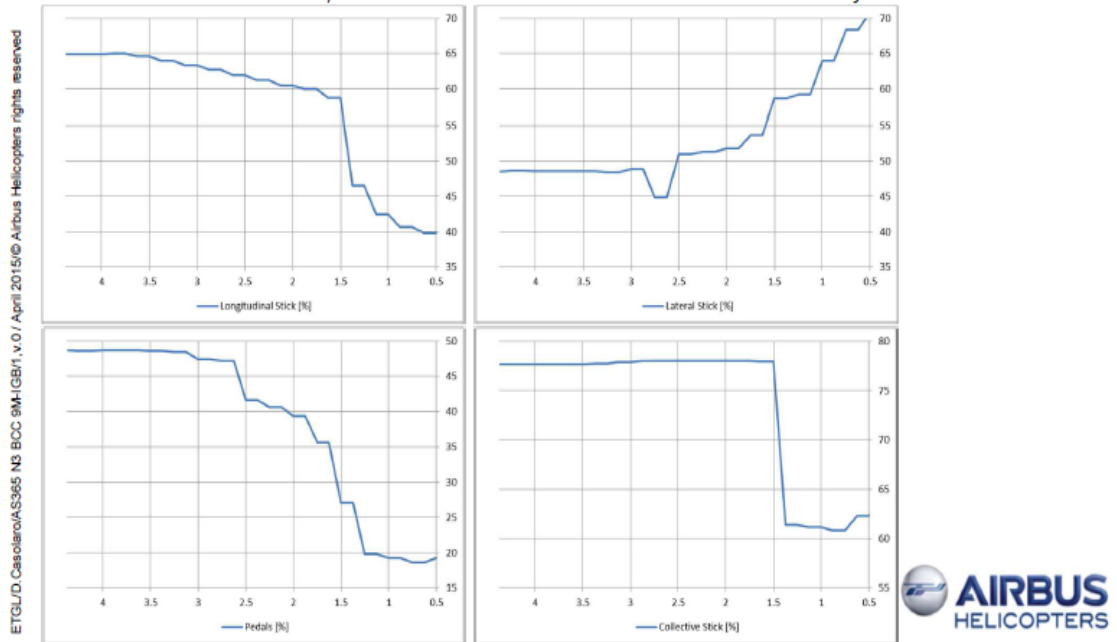
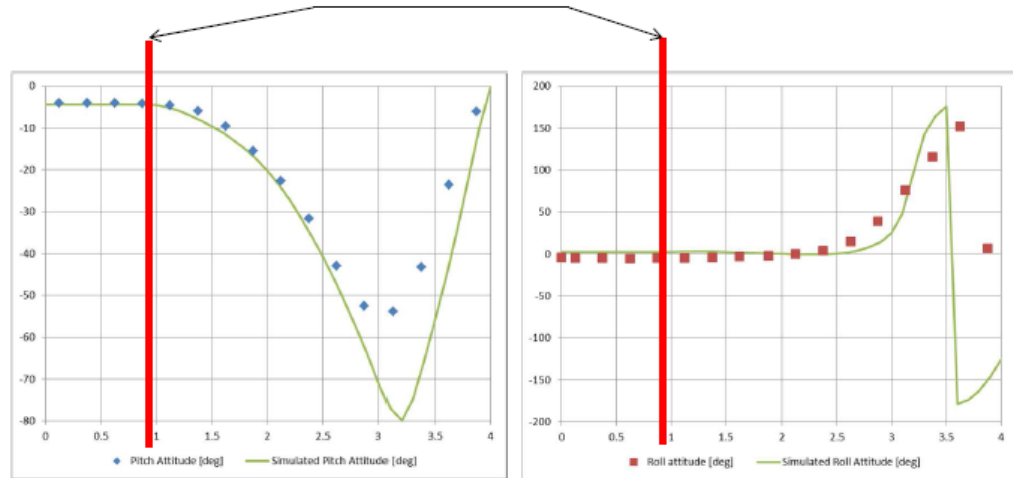

Fig 32

## Simulation results – Pitch and Roll

Suspected Loss of the left  
horizontal stabilizer



***Nota:*** Once the vertical load factor  $-1g$  is reached the simulation can differ from the real flight as the aircraft is completely outside of the certified flight envelope

The observed result of the simulation is consistent with the FDR



Fig. 33

### **3. CONCLUSIONS**

#### **3.1. Findings**

3.1.1 SSCVFDR information and inspection of the last landing area before the accident revealed that the helicopter had its left main landing gear sunk into loose soil while attempting a landing at an open field at Sekolah Kebangsaan Ladang Kota Bahagia. The left landing gear had sunk to approximately 20 inches deep into the soft ground causing the helicopter to tilt more than 13 degrees to the left. The LH horizontal stabiliser vertical fin and the tail section below the tail rotor fenestron had impacted the ground causing some damage to the inboard root of the LH horizontal stabiliser.

3.1.2 There was also evidence of excessive fluid leak in the sink hole made by the left landing gear as well as on the grass about 10 meters forward of the landing point. The fluid could have originated from the LH landing gear oleo strut and hydraulic brake system. However, no hydraulic warning was triggered during the check performed by the pilot before taking off,

3.1.3 The pilot was seen by a witness to have exited the helicopter and accompanied the disembarked passenger clear of the main rotor area. However, he did not carry out any inspection of the helicopter.

3.1.4 The main wreckage was concentrated at one area in a ravine. The 4 main rotor blades were found at different places from the main wreckage. The tail rotor and the right horizontal stabiliser was found about 200 meters away from the main wreckage.

3.1.5 Both the left and right engines parameters were operating normally.

3.1.6 At the end of the recording, as the helicopter was flying under auto pilot at 148 kts., the pitch of the helicopter unexpectedly and significantly decreased. The helicopter rapidly went beyond the flight envelop limits without any pilot input.

3.1.7 Inspection on the reconstruction of the wreckage revealed that the main rotor blades had struck the cowling, tail boom, fenestron and the left cabin door while the helicopter was still in the air. This action is considered consequential and there was no indication that the helicopter had struck terrain or any trees in flight prior to the impact. The helicopter descended almost vertically to the main wreckage area.

3.1.8 The crew was properly licenced and proficient to fly the helicopter,

3.1.9 The helicopter maintenance contract with Airbus Helicopter was properly carried out as per the maintenance programme and there was no anomaly in the maintenance documents.

3.1.10 The history of previous repair works on the helicopter by Airbus Helicopter did not reveal any anomaly that could contribute to the structural failure of the helicopter in flight.

### **3.2 Cause**

3.2.1 The cause of the accident was due to the separation of the left horizontal stabiliser in flight causing the helicopter to dive and bank to the right exceeding its flight envelope. The main rotor blades subsequently severed the tail boom and severed parts of the air frame resulting in the accident.

3.2.2 The following factors contributed to the accident :

- a) Unplanned landing at an open field causing the left main landing gear to sink into loose soil. The vertical fin attached to the LH horizontal stabiliser contacted the soil and subsequently fracture the inboard root of the LH horizontal stabiliser.
- b) Failure of the pilot to conduct detailed damage assessment of the left main landing gear knowing presence of excessive oil leak and damages to other parts of the helicopter.
- c) A descending high cruising speed compounded with landing gears down would aerodynamically put excessive loads on the fractured left horizontal stabiliser.
- d) Passenger intervention to pilot to return home on several occasions could create peer pressure on the pilot to rush for flying home.

#### **4. SAFETY RECOMMENDATIONS**

It is recommended that:

4.1 Pilot in command is to conduct pre flight for every flight and to include risk assessment on the route and destination for suitability before the flight commence. The DGCA notification letter dated 17 August 2015, with reference to Appendix 10.

4.2 Helicopter pilot is to avoid landing at any places unplanned whether on their own or passenger descretion except when obselutely necessary, such as in emergency situation.

4.3 DCA is to determine the necessity for flight manifest for all private flights. The DGCA notification letter dated 17 August 2015, with reference to Appendix 10.

4.4 DCA is to study activation of Emergency Locator Beacon fitted to the helicopter after non-activation several accidents involving emergency hard landing.

4.5 DCA to review the validity of private pilot licence previleges, when the holder is having professional licence.

4.6 DCA to review on the procedure for single pilot helicopter operations, in order to ensure safety for passenger embarkation or disembarkation with the engine and main rotor running.

4.7 The pilot in command is to ensure that passenger occupying the co-pilot's seat is prohibited from taking part in the operations of the helicopter.

**Inspector In-Charge  
Air Accident Investigation Bureau  
MALAYSIA**



# APPENDICES

International Flight Plan			
PRIORITY	ADDRESSEE(S)		
<<= FF			
Filing time	Originator		<<=
Specific identification of addressee(s) and/or originator			
3. MESSAGE TYPE	7. AIRCRAFT IDENTIFICATION	8. FLIGHT RULES	TYPE OF FLIGHT
<<= ( FPL	9M-IGB	<input checked="" type="checkbox"/> V	G <<=
9 NUMBER	TYPE OF AIRCRAFT	WAKE TURBULENCE CAT.	10 EQUIPMENT
01	AS365N3	L	SD/C <<=
13 DEPARTURE AERODROME		TIME	
WMKD		0400 <<=	
15 CRUISING SPEED	LEVEL	ROUTE	
N0130	A015	WMKD - PEKAN - MUADZAM SHAH - BANDAR TUN RAZAK - KUALA KLAWANG - KAJANG - THE MINES - PJ - WMSA	
<<=			
16 DESTINATION AERODROME	TOTAL EET	ALTN AERODROME	2 <sup>ND</sup> ALTN AERODROME
ZZZZ	HR MIN 01 10	ZZZZ	ZZZZ <<=
DOF:150404 EET: PEKAN 0009// MUADZAM SHAH 0014// BANDAR TUN RAZAK 0025/ KUALA KLAWANG 0014/ KAJANG 0010/ THE MINES 0004// PJ 0003/ WMSA 0003//			
OPR: SOLAIRE HELICOPTER CORP S/B			
RMK: PRIVATE FLIGHT. <<=			
Supplementary information (not to be transmitted in FPL message)			
19 ENDURANCE	PERSONS ON BOARD		EMERGENCY RADIO
HR MIN	P /		UHF VHF ELBA
TBN	P / TBN		R / <input checked="" type="checkbox"/> <input checked="" type="checkbox"/> <input checked="" type="checkbox"/>
SURVIVAL EQUIPMENT		JACKETS	
POLAR DESERT MARITIME JUNGLE	LIGHT FLARES UHF VHF		
S / <input checked="" type="checkbox"/> <input checked="" type="checkbox"/> <input checked="" type="checkbox"/> <input checked="" type="checkbox"/> <input checked="" type="checkbox"/>	X / L F U V		
DINGHIES	NUMBER CAPACITY COVER COLOR		
X /	X		<<=
AIRCRAFT COLOR AND MARKINGS			
A / MAROON WITH YELLOW MARKINGS			
REMARKS			
N /	+KIT <<=		
PILOT-IN-COMMAND			
C /	CLIFF FOURNIER ) <<=		
FILED BY	ADDITIONAL INFORMATION		
ASYRAF 0162016075	CLIFFORD WILLIAM 019 231 7778		



**Appendix 2, Figure 2**



LANDING AT MUAZZAM SHAH TO VISIT ABUNDONED FACTORY

**Appendix 2, Figure 3**



OLD ABUNDANT FACTORY

SEKOLAH KEBANGSAAN LADANG KOTA BAHAGIA (FOOTBALL FIELD)  
VIEW OF THE LANDING AREA



LAST LANDING POINT – FOOTBALL FIELD



## CVR TRANSCRIPT

UTC Time	Captain	Other (ATC, Passengers...)	Remarks, sound and alarms
06 h 46 min 58 s	Beginning of recording		
08 h 20 min 00 s	Beginning of transcription		
08 h 20 min 15 s 700			Decision Height warning
08 h 20 min 31 s 400			Impulse noise (CAM track)
08 h 20 min 31 s 500	(!)		Reaction of surprise of the Captain
08 h 20 min 31 s 800		<b>Passenger:</b> Oh watch out, watch out!!	
08 h 20 min 33 s 800	Landing gear		
08 h 20 min 34 s 800	Why isn't my landing gear down?		
08 h 20 min 36 s 500		(*)	
08 h 20 min 38 s 400			Variation of engine noise
08 h 20 min 39 s 100			Gong
08 h 20 min 39 s 700			Decision Height warning
08 h 20 min 39 s 900	Why isn't my landing gear down?		
08 h 20 min 41 s 500		<b>Passenger:</b> Gear down	
08 h 20 min 42 s 100	My gear fell over		
08 h 20 min 46 s 140	I got three in the green		
08 h 20 min 52 s 700	Can you euh...?		
08 h 20 min 54 s 500		<b>Passenger:</b> Then we should go, just go back to (*)	
08 h 20 min 56 s 800	Yeah, I'm a little nervous about this now, let me see		

## CVR TRANSCRIPT

08 h 21 min 02 s 000		<b>Female voice:</b> It's ok, it's euh... the (dirt) of the back, it's okay	
08 h 21 min 10 s 600	There is a wheel or what?		
08 h 21 min 11 s 900		<b>Female voice:</b> Yes wheel, wheel went to... into the ground	
08 h 21 min 13 s 090			Decision Height warning
08 h 21 min 14 s 600		<b>Female voice:</b> It's a soft ground there, after the rain	
08 h 21 min 16 s 500		<b>Passenger:</b> Soft ground	
08 h 21 min 18 s 000		<b>Passenger:</b> A soft ground	
08 h 21 min 18 s 100		<b>Female voice:</b> We're good, we're good	
08 h 21 min 19 s 500	You're good?		
08 h 21 min 20 s 100		<b>Female voice:</b> Yes	
08 h 21 min 20 s 300	We're staying up?		
08 h 21 min 23 s 000		<b>Female voice:</b> Yes, yes, yes. We're good.	
08 h 21 min 23 s 900	Look at the (hole of that)!		
08 h 21 min 25 s 400		<b>Female voice:</b> It's a soft ground after the rain, it's a field	
08 h 21 min 28 s 500	Wow, but...		
08 h 21 min 28 s 800		<b>Female voice:</b> It's football field	
08 h 21 min 29 s 100	That's... that's was crazy		
08 h 21 min 32 s 600	Okay?		
08 h 21 min 33 s 400		<b>Female voice:</b> Yes, we're good, we're good	
08 h 21 min 35 s 000	Okay we're locked in		
08 h 21 min 36 s 100		<b>Female voice:</b> Yep	



## CVR TRANSCRIPT

08 h 21 min 38 s 900		<b>Passenger:</b> You didn't (*) the engine	
08 h 21 min 39 s 600			Multi-gong (DIFF NG warning)
08 h 21 min 40 s 100	Yeah, I just euh, I just...		
08 h 21 min 40 s 900	(*)		Low RPM Warning (continuous during 1 min 46 s)
08 h 21 min 41 s 700		<b>Passenger:</b> What are you doing?	
08 h 21 min 42 s 600		<b>Passenger:</b> What you doing? We (*) on wheel	
08 h 21 min 42 s 700			Decision Height warning
08 h 21 min 44 s 700		<b>Passenger:</b> (You stay, you stay)	
08 h 21 min 45 s 700		<b>Background voice:</b> (*)	
08 h 21 min 46 s 600		<b>Passenger:</b> Okay	
08 h 21 min 48 s 300			Microphone handling noise
08 h 21 min 49 s 600		<b>Female voice:</b> It's okay (*)	
08 h 21 min 54 s 700			Microphone handling noise
08 h 23 min 06 s 100			Microphone handling noise
08 h 23 min 15 s 500	(*)		
08 h 23 min 17 s 300	Take a picture of that for me, will you, that hole		
08 h 23 min 20 s 200	(*)		
08 h 23 min 22 s 400			Multi-gong (DIFF NG warning)
08 h 23 min 23 s 100			Multi-gong (DIFF NG warning)
08 h 23 min 25 s 800	Yeah, it's okay, I'll hover over there in a minute		
08 h 23 min 26 s 800			End of low NR warning

## CVR TRANSCRIPT

08 h 23 min 41 s 000		<b>Background voice:</b> (*)	
08 h 24 min 04 s 200	(...)		
08 h 24 min 13 s 100		<b>Female voice:</b> (...)	
08 h 24 min 28 s 800		<b>Female voice:</b> This helicopter can take any kind of (rain) (*)	
08 h 24 min 35 s 500	Yeah, we are out of the rain, no problem		
08 h 24 min 37 s 000	Tower is there		
08 h 24 min 38 s 400		<b>Female voice:</b> Yeah	
08 h 24 min 48 s 400	We'll leave our landing gear down		
08 h 24 min 51 s 700	No, no leave it down, leave it down		
08 h 25 min 00 s 200	(*) Yeah, you never know what happened, it's very unusual to get that far over		
08 h 25 min 08 s 000		<b>Female voice:</b> It's Ok, it's football field	
08 h 25 min 48 s 200		<b>Female voice:</b> How long it takes?	
08 h 25 min 50 s 200	Euh...		
08 h 26 min 04 s 500	About thirty seven minutes		
08 h 26 min 18 s 600	And (...) you go to The Mines?		
08 h 26 min 20 s 400		<b>Passenger:</b> (*)	
08 h 26 min 22 s 800		<b>Passenger:</b> Yeah	
08 h 26 min 24 s 000	Go to The Mines?		
08 h 26 min 24 s 800		<b>Passenger:</b> Yes please	

## CVR TRANSCRIPT

08 h 28 min 39 s 800		<b>Female voice:</b> Mike is ON?	
08 h 28 min 41 s 700	Yeah, mike is ON		
08 h 28 min 44 s 200	Yes, it's definitely not good to tip like that		
08 h 28 min 50 s 000	I don't euh... it's not..., I have seen hydraulic fluid leaking that's why they (*)		
08 h 28 min 55 s 500	I don't want to put them up		
08 h 28 min 57 s 600	They are locked in the down position, let's keep them in the down position		
08 h 29 min 01 s 000			
<b>This part has not been exhaustively transcribed</b>			
08 h 53 min 00 s 000			
08 h 53 min 08 s 800			VOR detection signal (Morse)
08 h 53 min 38 s 800			VOR detection signal (Morse)
08 h 53 min 57 s 830			Transient noise
08 h 53 min 58 s 330			Noise similar to an air flow
08 h 53 min 58 s 530			Blade impact noise
08 h 53 min 59 s 930			Gong
08 h 54 min 00 s 220			High NR Warning
08 h 54 min 00 s 730			Unknown warning
08 h 54 min 01 s 330	<b>End of recordings</b>		

## CVR TRANSCRIPT

**Notes:**

- *The above is partial transcript from the CVR recording audio. This transcript contains conversations between crew members and various noises corresponding, for example, warnings or the movement of selectors.*
- 
- *The reader's attention is drawn to the fact that the recording and transcript of a CVR are only a partial reflection of events and of the atmosphere in a cockpit. Consequently, the utmost care is required in the interpretation of this document. The voices of crew members are heard via the different channels of the CVR (CAM and headset microphone). They are placed in separate columns for reasons of clarity. Two other columns are reserved for others exchange (ex: cabin crew members, passengers, other aircraft, ATC communications ...) and sounds and warnings*
- *heard via the CAM.*

**Glossary:**

- *(\*) Word or group of words not understood*
- *(!) Exclamations, curse*
- *(...) Word or group of words with no link with the flight*
- *( ) Doubtful word or group of words*
- 
- *UTC Timing synchronized with ATC communication*

# WRECKAGE DISTRIBUTION

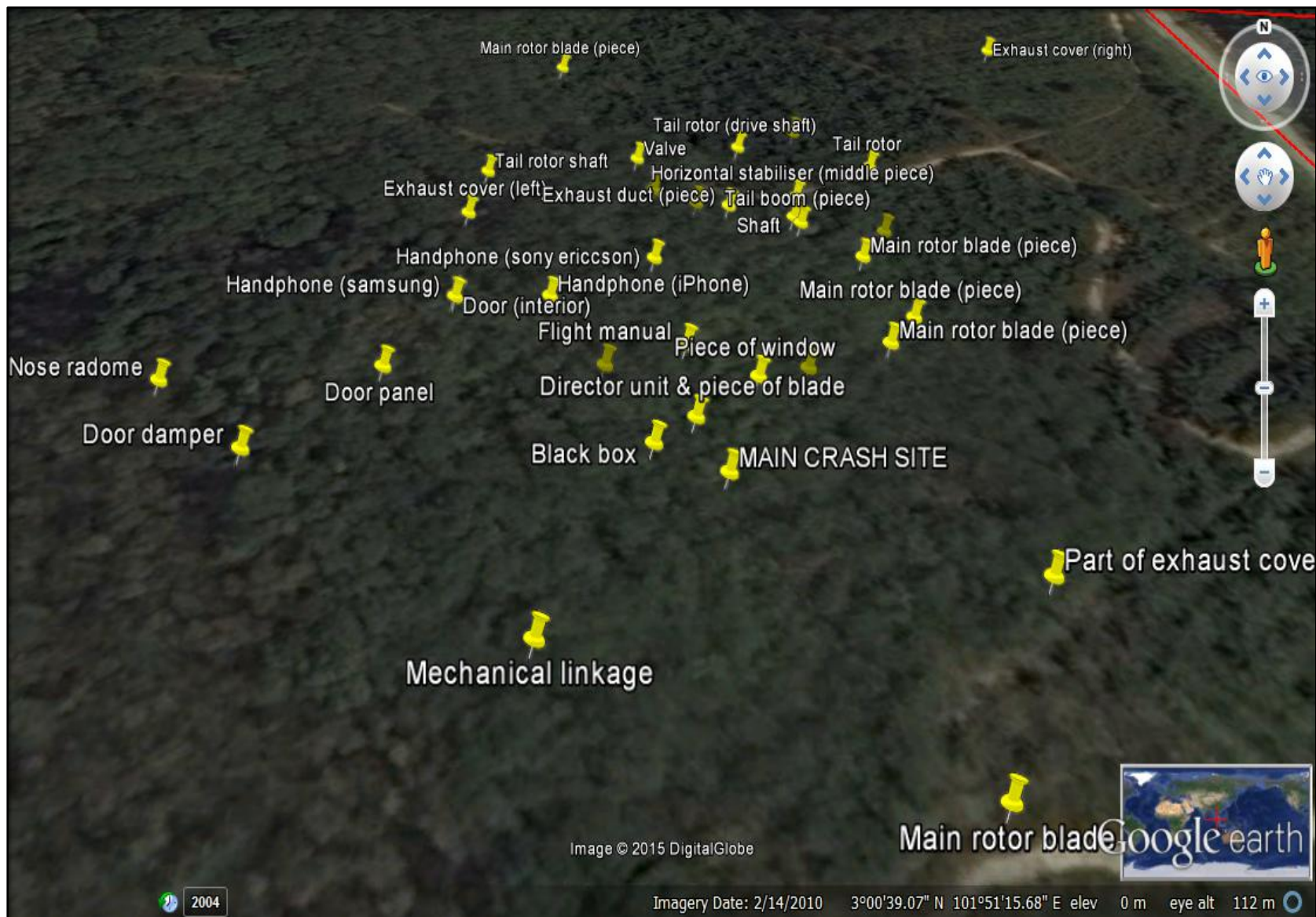

Image © 2015 DigitalGlobe

Main rotor blade Google earth

2004

Imagery Date: 2/14/2010 3°00'39.07" N 101°51'15.68" E elev 0 m eye alt 112 m

**Appendix 5, Figure 1**



**EXTENSIVE DAMAGE TO MAIN ROTOR BLADES**

**Appendix 5, Figure 2**



**EXTENSIVE DAMAGE TO MAIN ROTOR BLADE ROOT**



**SEPERATION OF THE MAIN ROTOR BLADES UNDER HIGH  
ROTATIONAL SPEED**



**SEVERE DAMAGE ON THE LOWER PART OF THE  
FENESTRON**



BROKEN TAIL ROTOR BLADES UNDER HIGH ROTATIONAL SPEED



BROKEN BLADES DUE TO SUDDEN IMPACT WITH THE FENESTRON CASING





ENGINE CONDITION, SERIAL NUMBER 4270



SEVERAL NICKS ON THE COMPRESSOR BLADES



MANUFACTURER'S ALIGNMENT MARKS ON THE SPLINE  
AND BASE MOUNT



SEVELY BENT AND JAGGED COMPRESSOR BLADES DUE TO  
INGRESS OF FODs.

**Appendix 5, Figure 11**



**BOROSCOPE INSPECTION AROUND THE IMPELLER SECTION**

**Appendix 5, Figure 12**



**POST IMPACT FIRE ON THE ENGINE**

**Appendix 5, Figure 13**



**CONDITION OF MAIN ROTOR HEAD ASSEMBLY**

**Appendix 5, Figure 14**

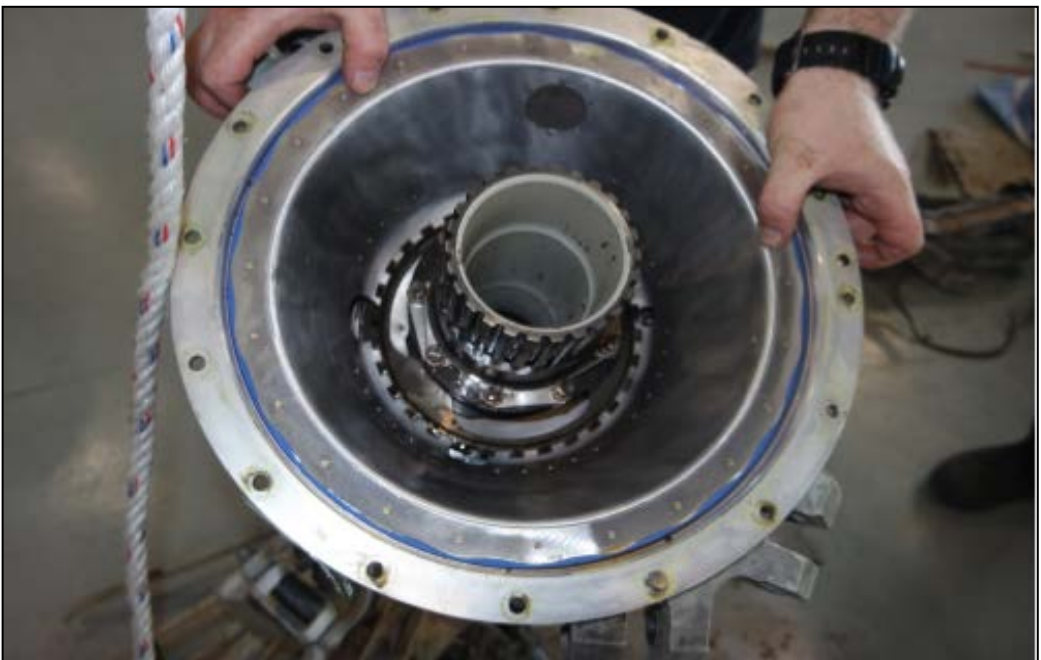

**CONDITION OF MAIN ROTOR GEARBOX**



CONDITION OF THE COVERED PARTS



PARTS RECOVERED ALONG THE HELICOPTER TRAJECTORY

POSITIONING OF THE PARTS IN RELATION TO THEIR LOCATION ON THE HELICOPTER



**Appendix 6, Figure 1**



**3 IMPACTS EVIDENCE ON THE REAR PART OF THE AIRFRAME**

**Appendix 6, Figure 2**



**3 IMPACTS EVIDENCE ON THE REAR PART OF THE AIRFRAME**



1 IMPACT ON THE FENESTRON FRAME (+ TAIL DRIVE SHAFT AND ON ENGINE COWLING)



1 IMPACT EVIDENCE ON THE TAIL BOOM(+ TAIL DRIVE SHAFT, ENGINE COWLING AND EXHAUST PIPES)



1 IMPACT EVIDENCE ON THE LEFT SIDE OF CABIN DOOR AND FORWARD COWLING

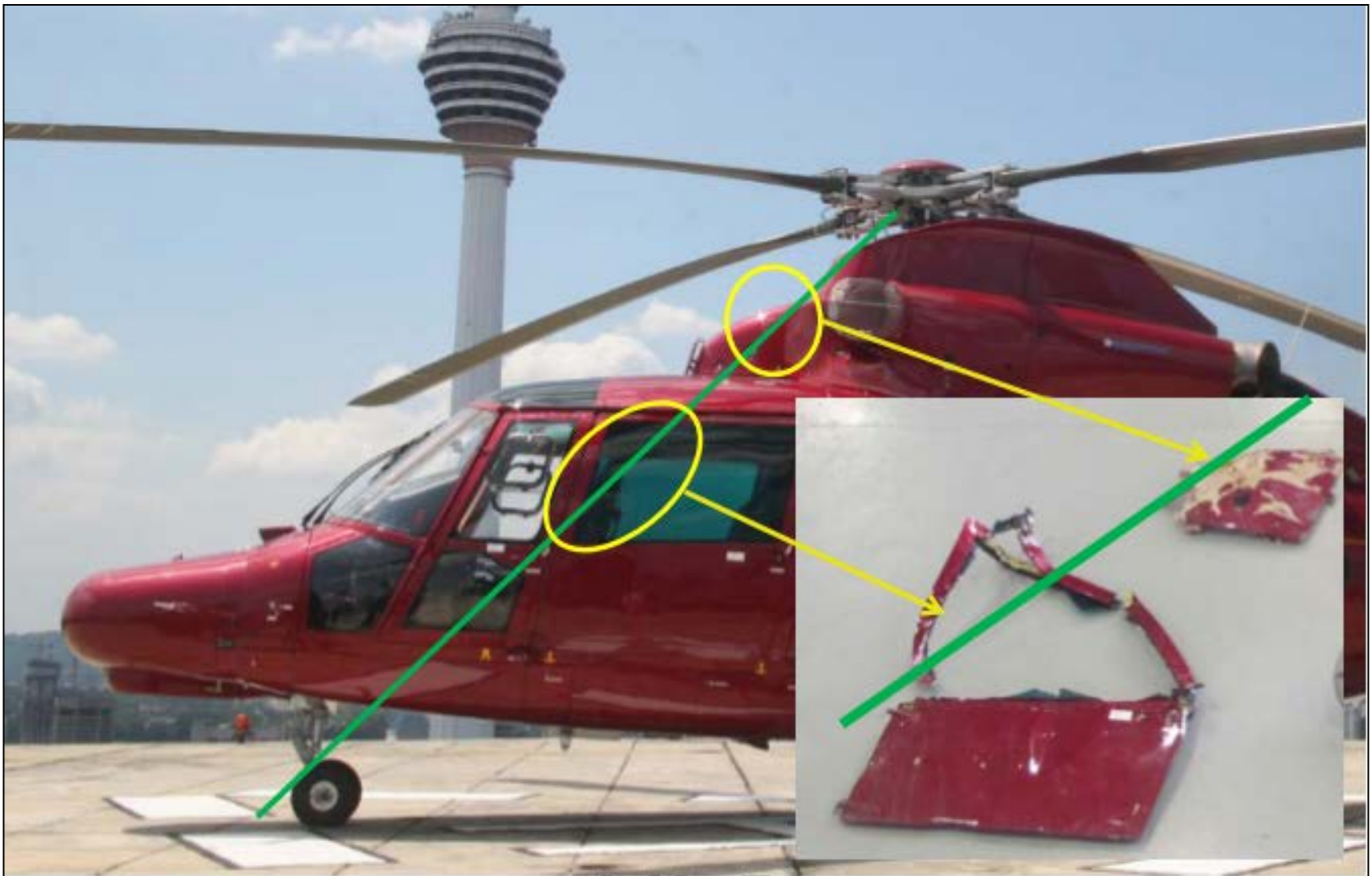

CPPI from KLIA Doppler Radar (3 – 5.30 pm)

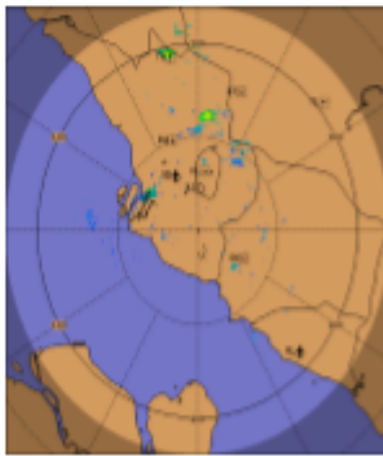

1. Imej radar pada pukul 3.00 petang

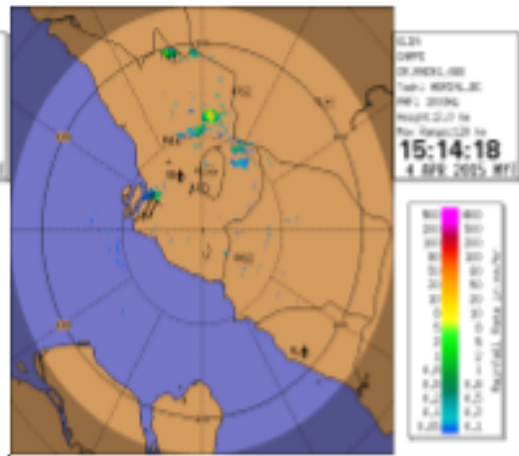

2. Imej radar pada pukul 3.14 petang

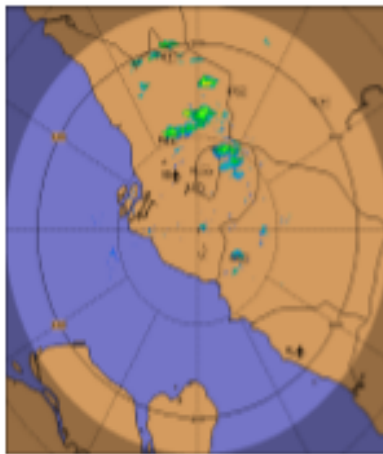

3. Imej radar pada pukul 3.31 petang

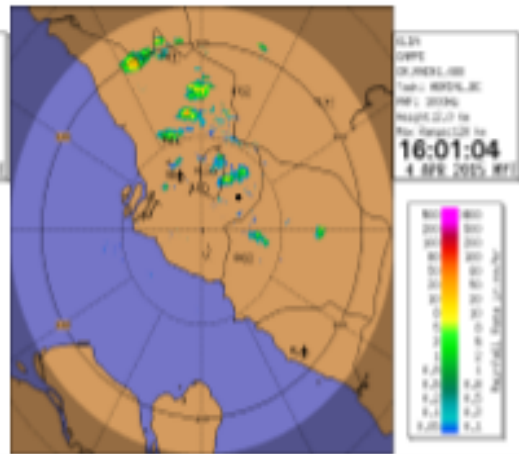

4. Imej radar pada pukul 4.01 petang

Nota: ● Lokasi Insiden 03° 00' 32"N, 101° 51' 37"E

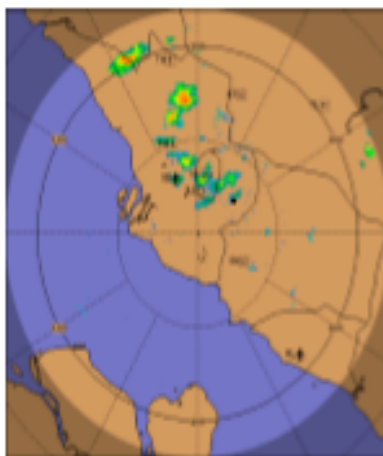

5. Imej radar pada pukul 4.18 petang



6. Imej radar pada pukul 4.30 petang

Nota: ● Lokasi Insiden 03° 00' 32"N, 101° 51' 37"E

CPPI from KLIA Doppler Radar (3 – 5.30 pm)

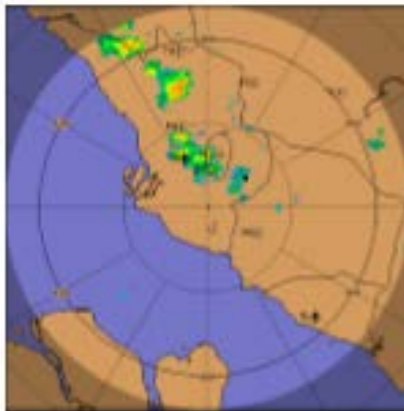

7. Imej radar pada pukul 4.47 petang

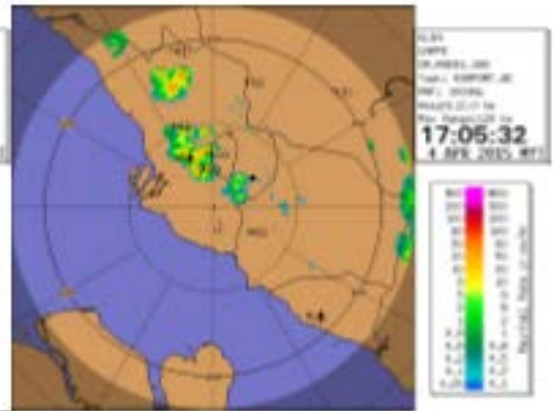

8. Imej radar pada pukul 5.05 petang.

Nota: ●Lokasi Insiden 03° 00' 32"N, 101° 51' 37"E



9. Imej radar pada pukul 5.17 petang

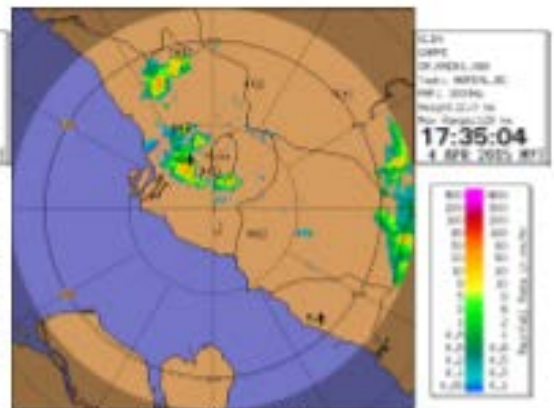

10. Imej radar pada pukul 5.35 petang

Satellite image MTSAT at 5.32pm

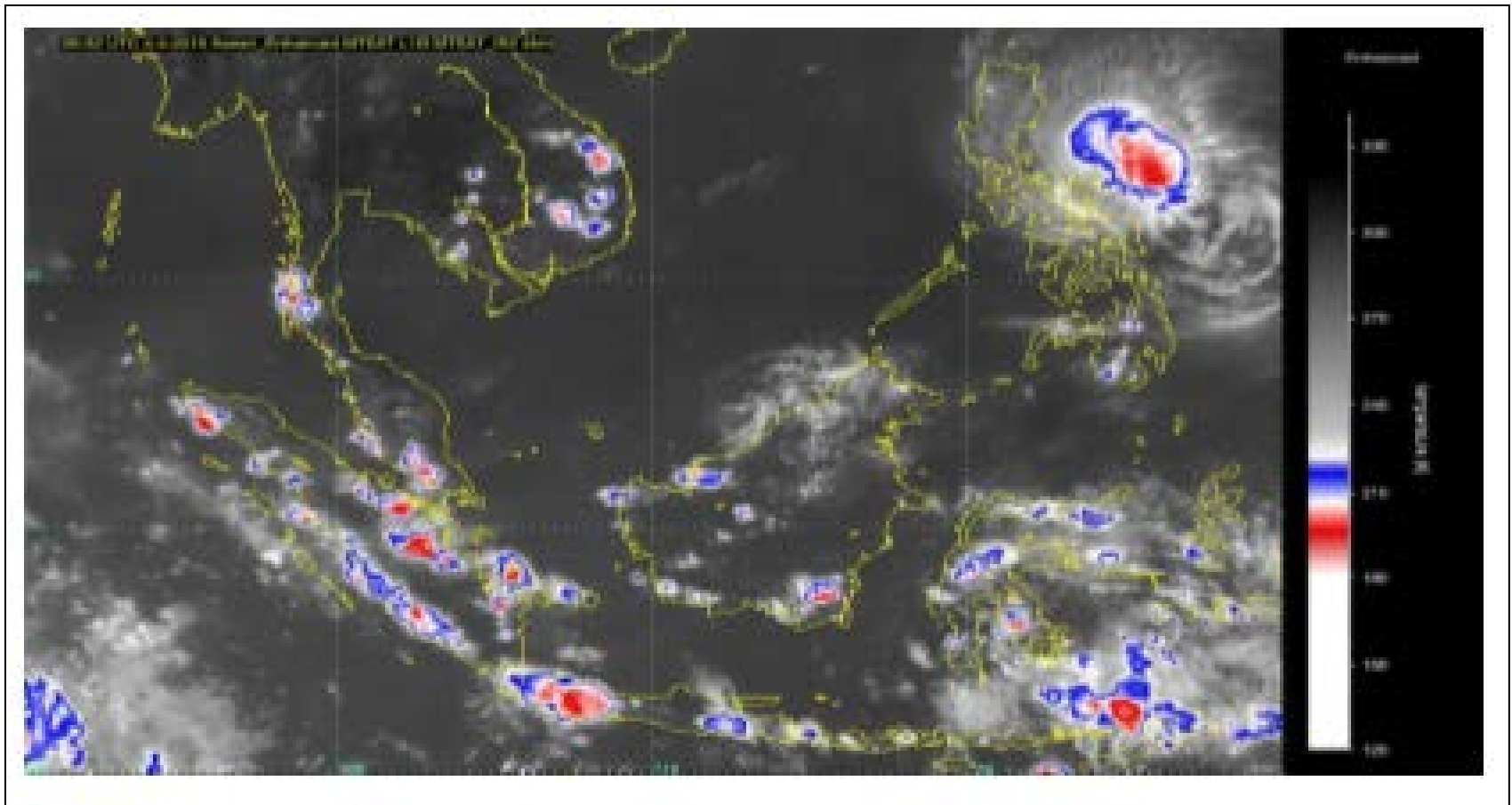

# LANDING IN THE OPEN FIELD – ACOUSTIC EVENT APPEARANCE – SOUND AND WARNINGS DESCRIPTION ( SPECTRUM OVERVIEW)

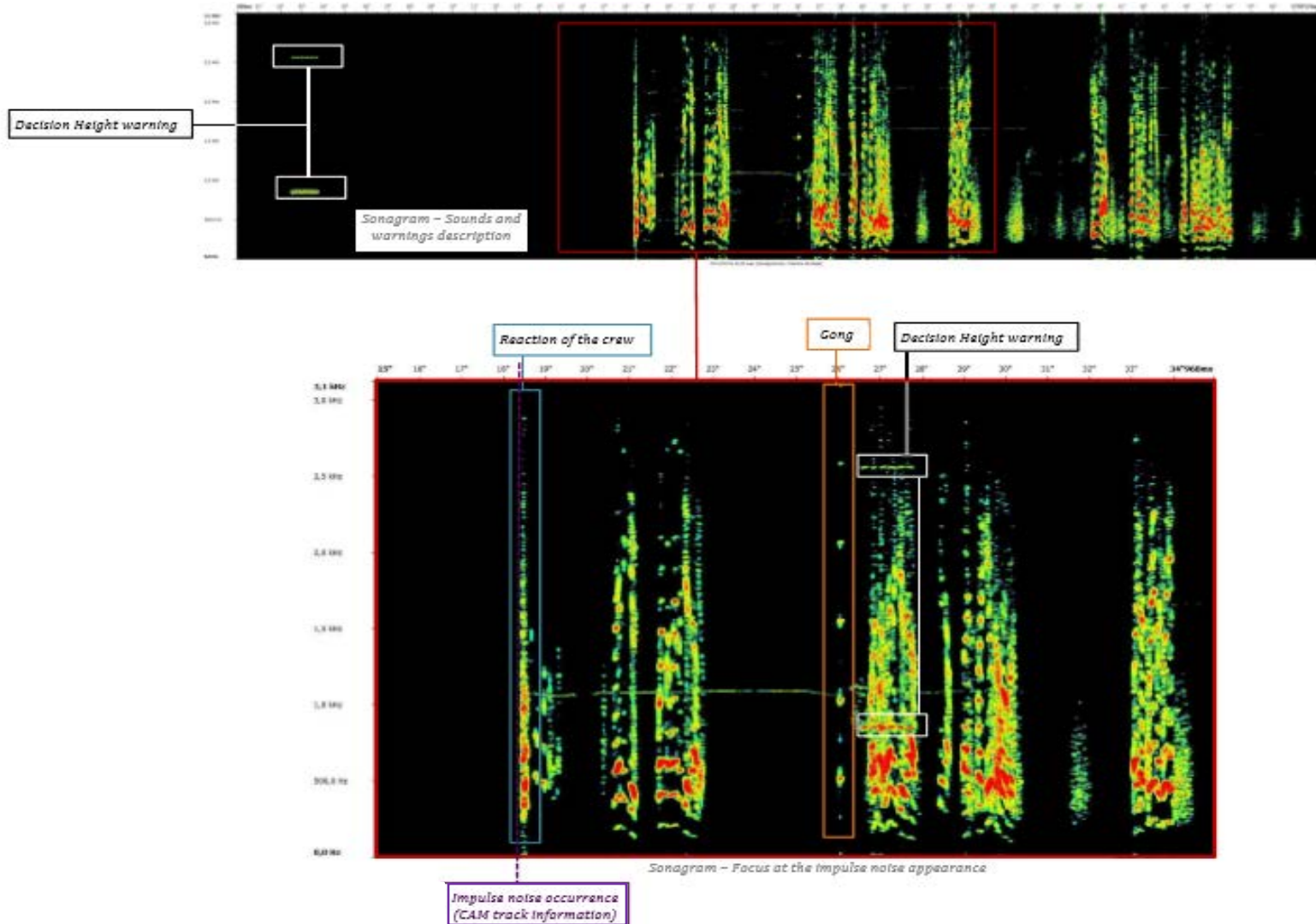

ACOUSTIC EVENTS DESCRIPTION (LAST 5 SEC OF RECORDING)- SPECTRUM OVERVIEW

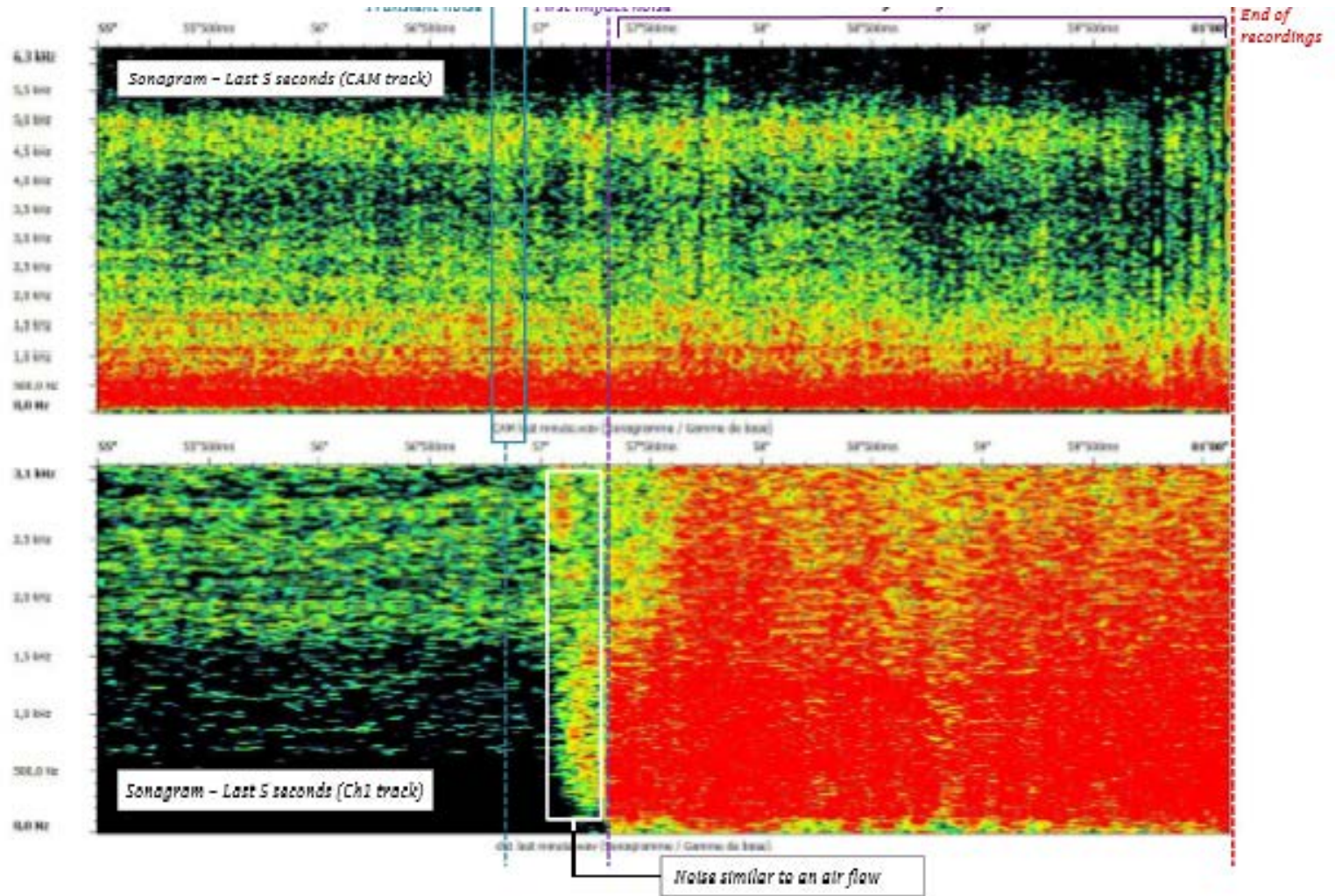

## 9M-IGB-PROPULSION SYSTEM CONDITION (LAST MINUTE OF RECORDING)-SPECTRUM OVERVIEW

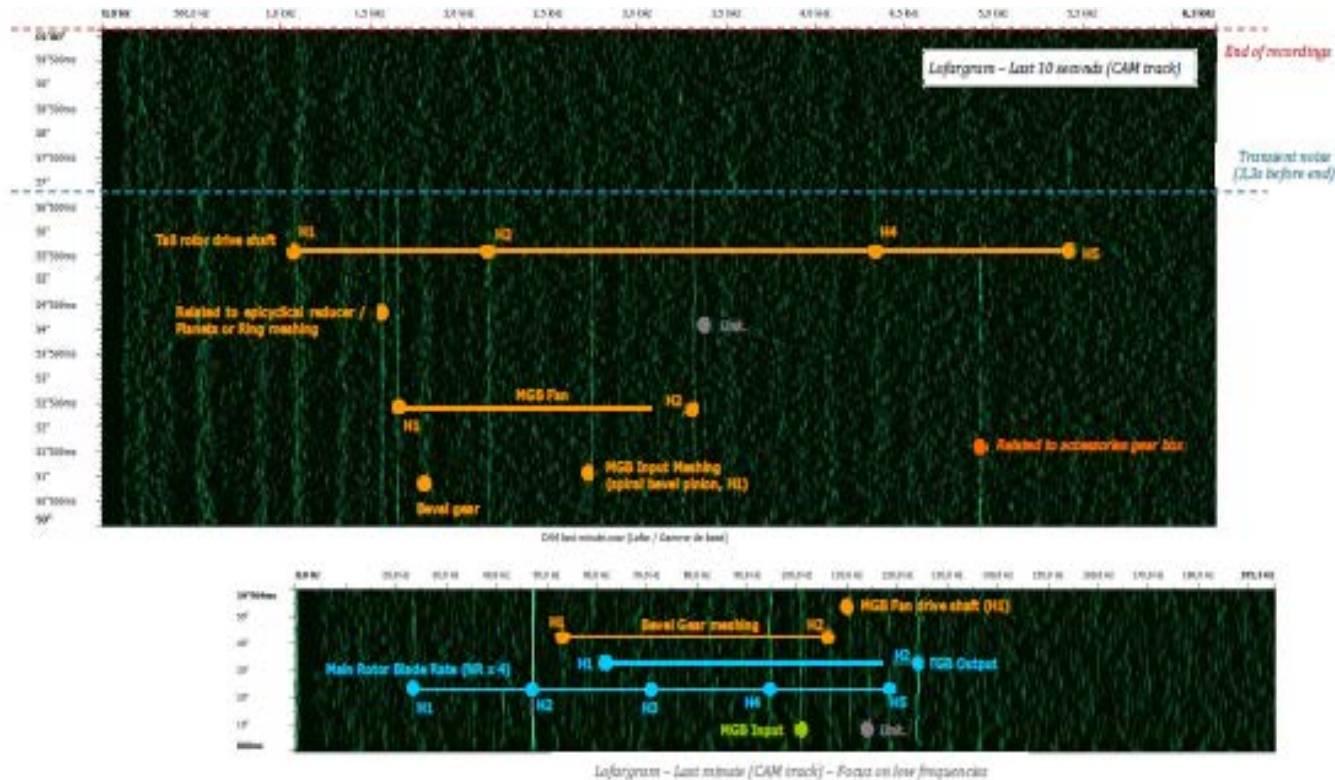

This acoustic signature was consistent with nominal acoustic signature normally observed on A6365 family helicopter. The propulsion system condition appeared to be nominal until 3.4 seconds before the end of recordings. At this moment, a transient noise was recorded on the CVR. 0.5 seconds after this noise (i.e. 2.8 s before the end of the audio recordings), the spectral lines associated with the helicopter propulsion system disappeared. This disappearance was simultaneous with the appearance of a high energy level phenomenon. Considering the wide band noise generated by this phenomenon, it was not possible to describe the behavior of spectral lines associated with the helicopter propulsion system.

# LANDING IN THE OPEN FIELD – ACOUSTIC EVENTS DESCRIPTION (CAM TRACK) – SPECTRUM OVERVIEW

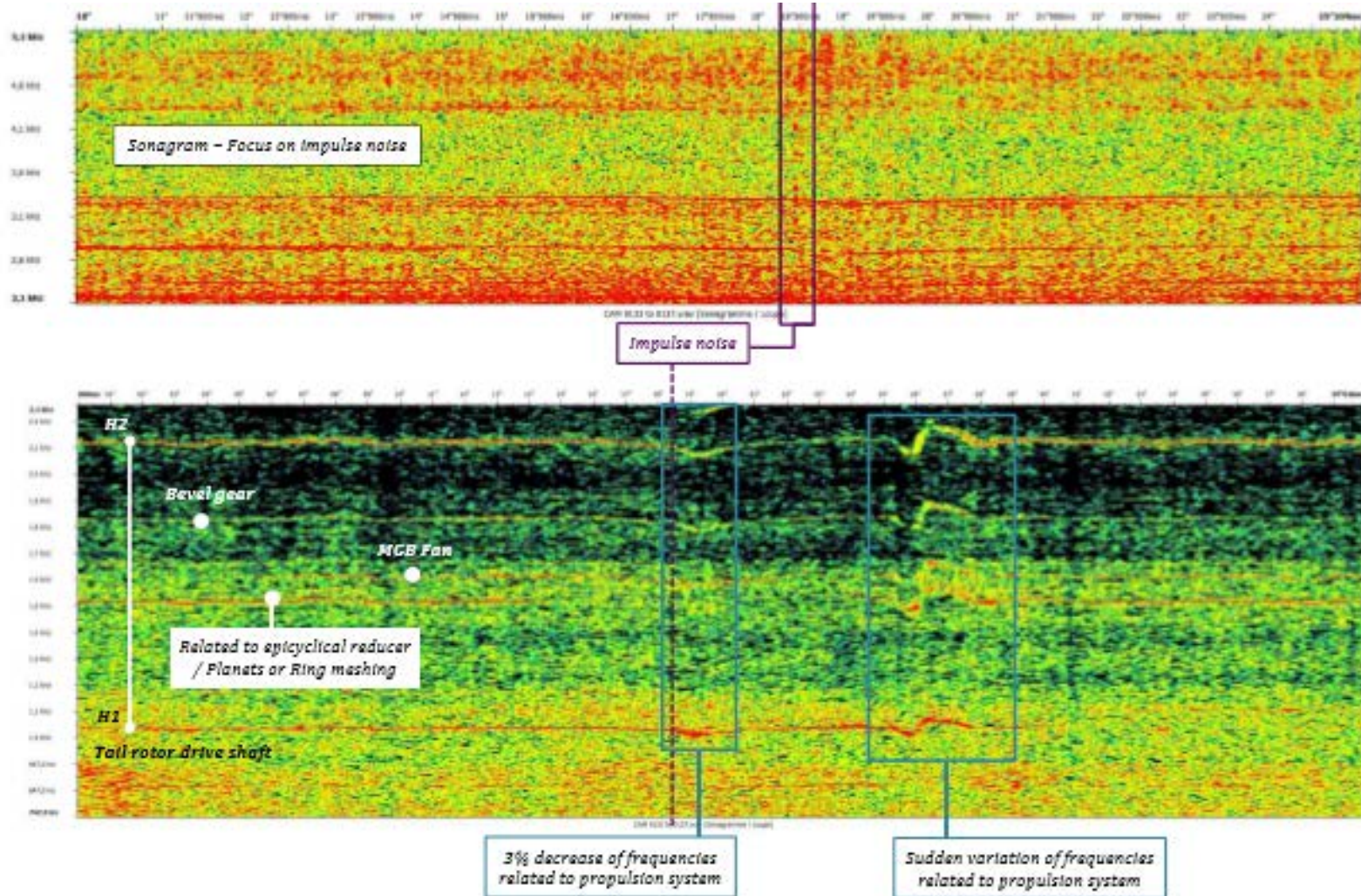





LANDING AT OPEN FIELD PARAMETERS - ZOOM

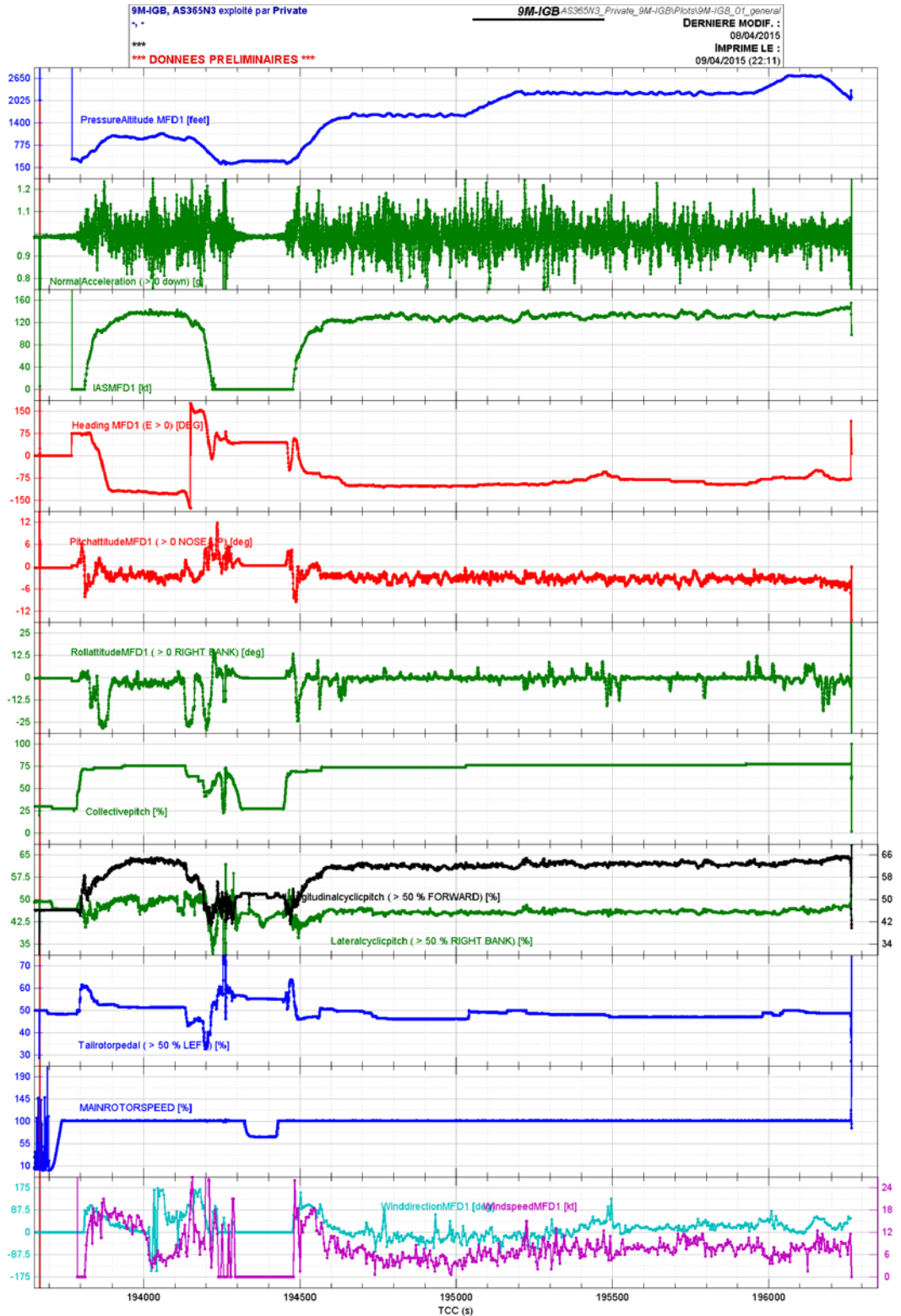

# FLIGHT PARAMETERS - ZOOM

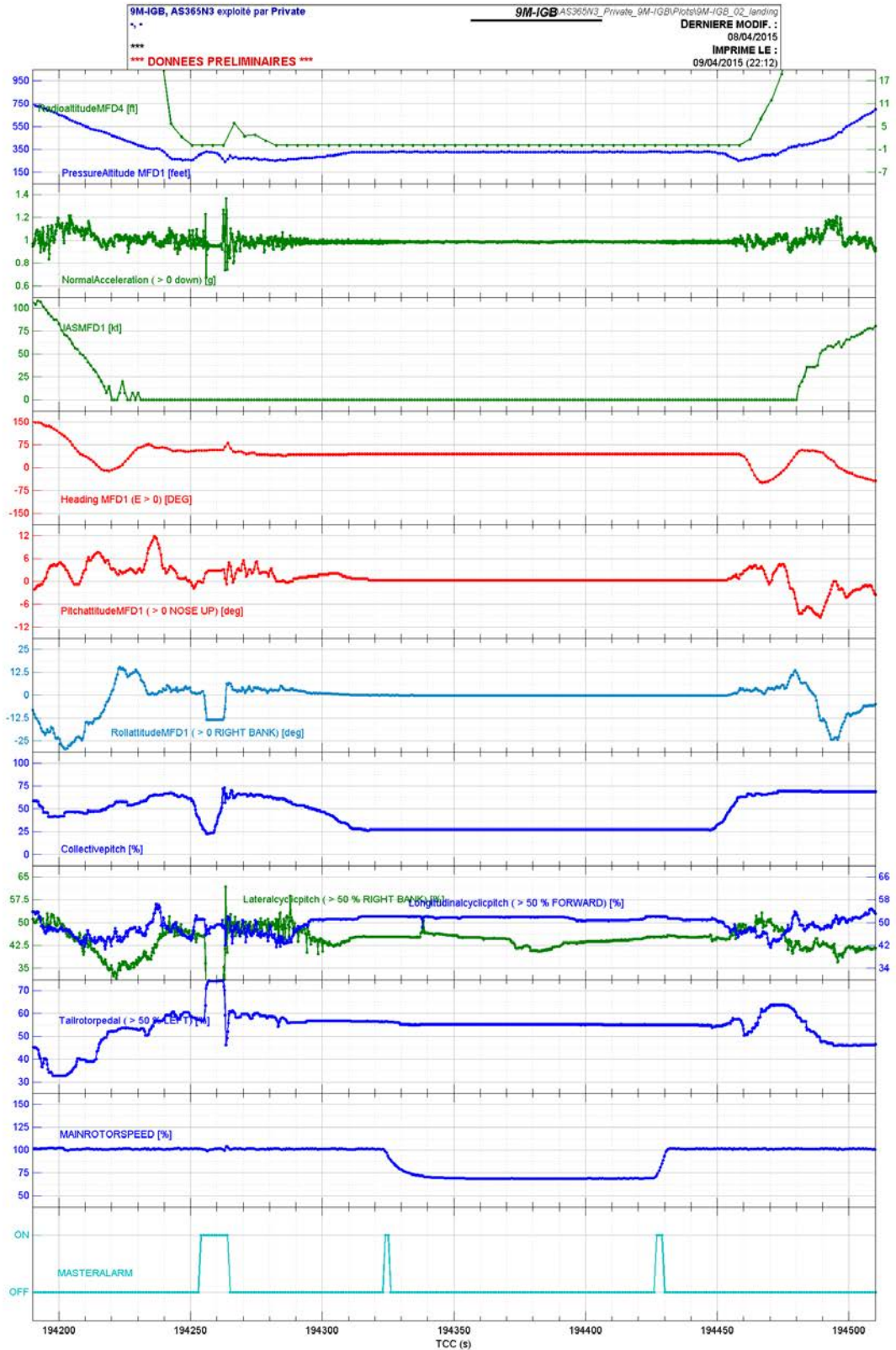

# LANDING OPEN FIELD PARAMETERS - ZOOM

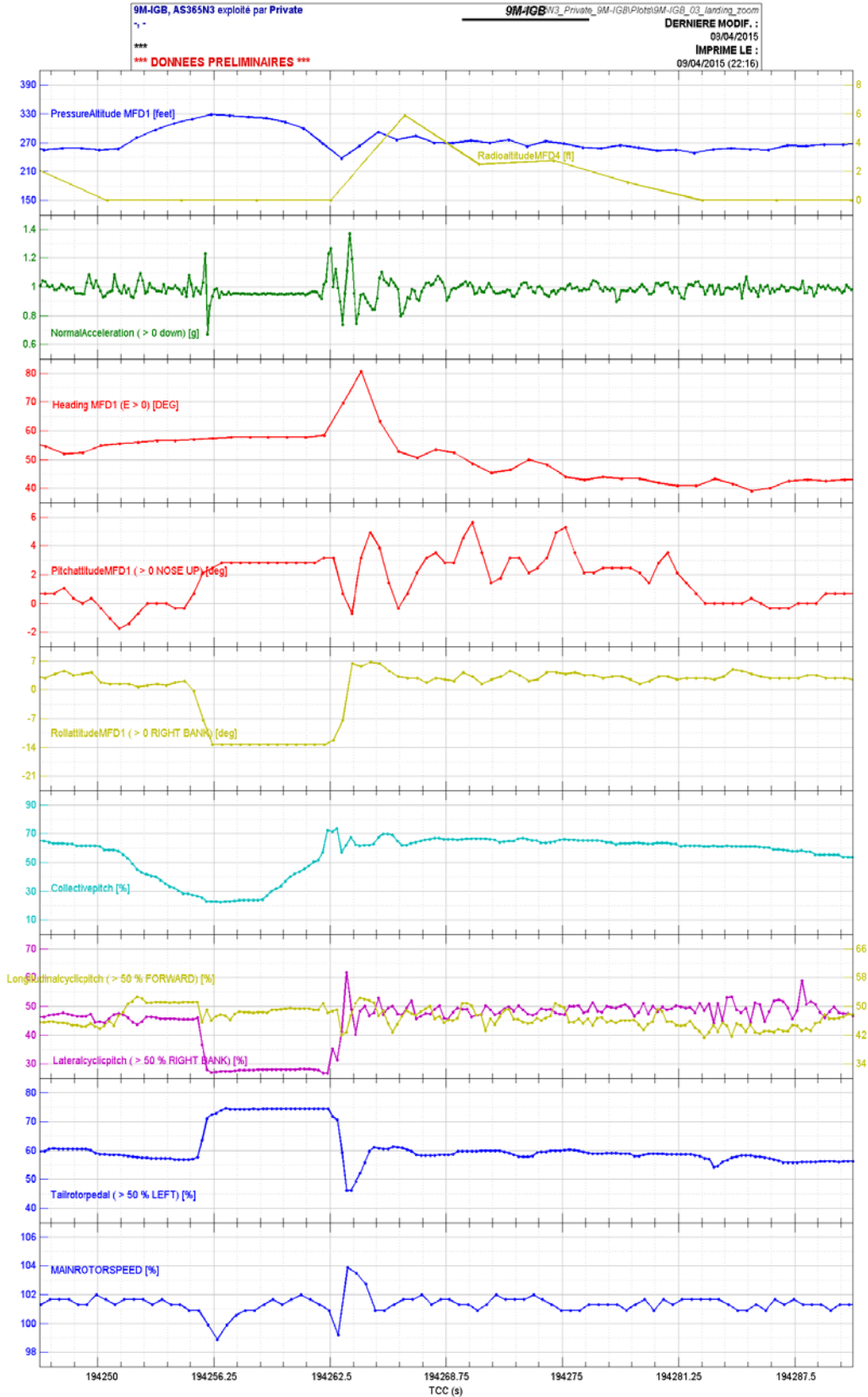

FLGHT PARAMETERS - ZOOM

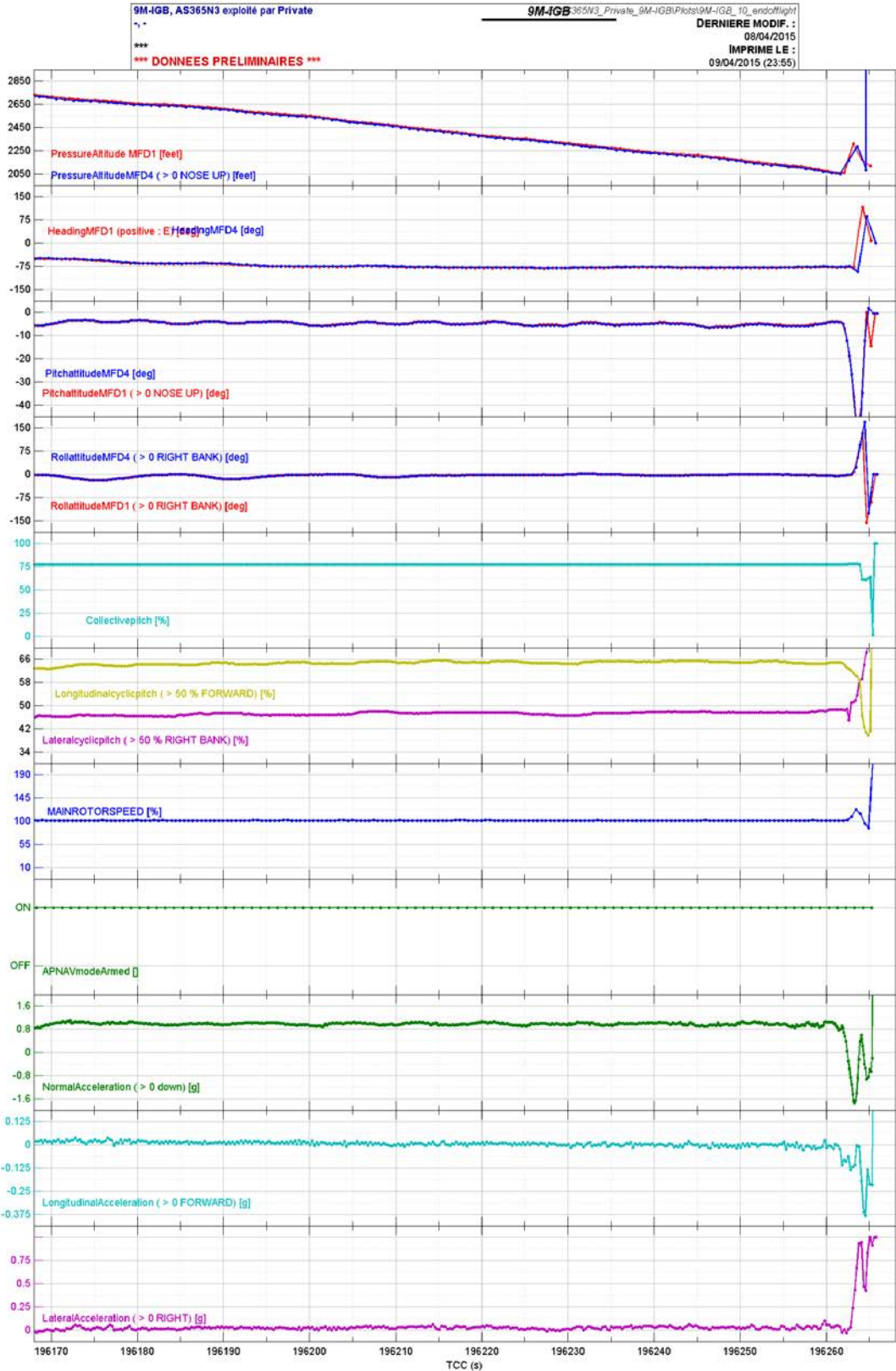

# FLIGHT PARAMETERS

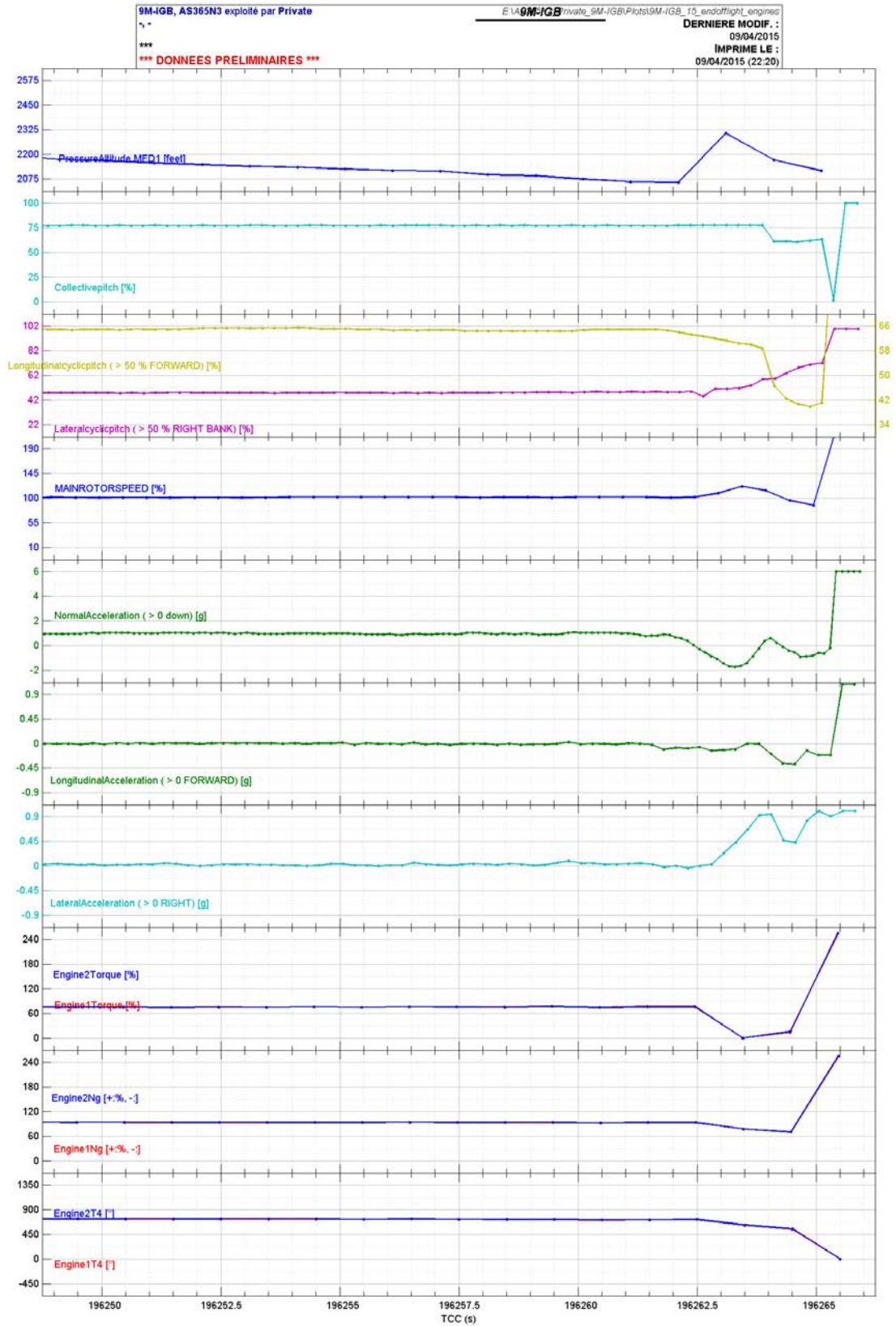

# END OF FLIGHT PARAMETERS

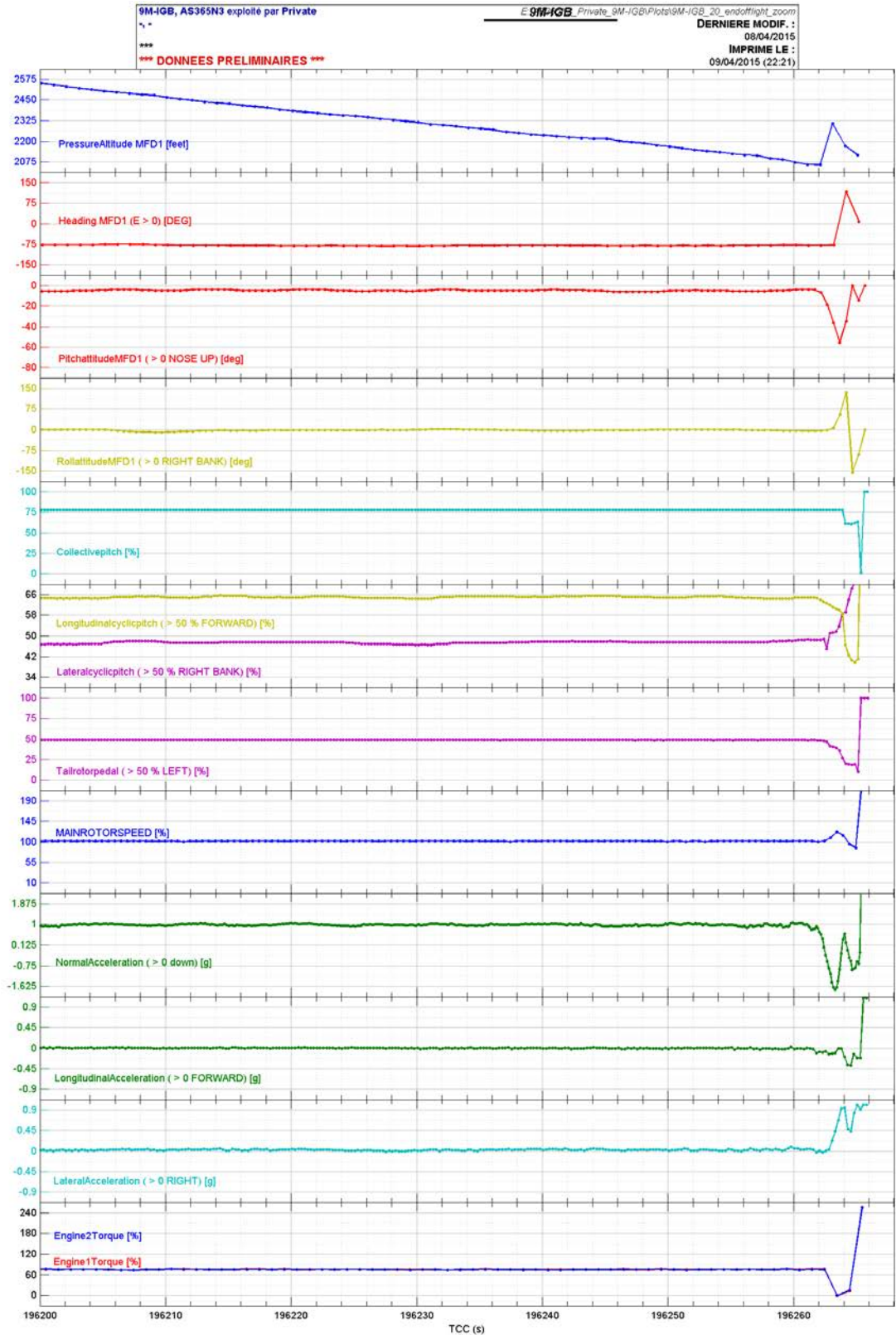

# END OF FLIGHT PARAMETERS

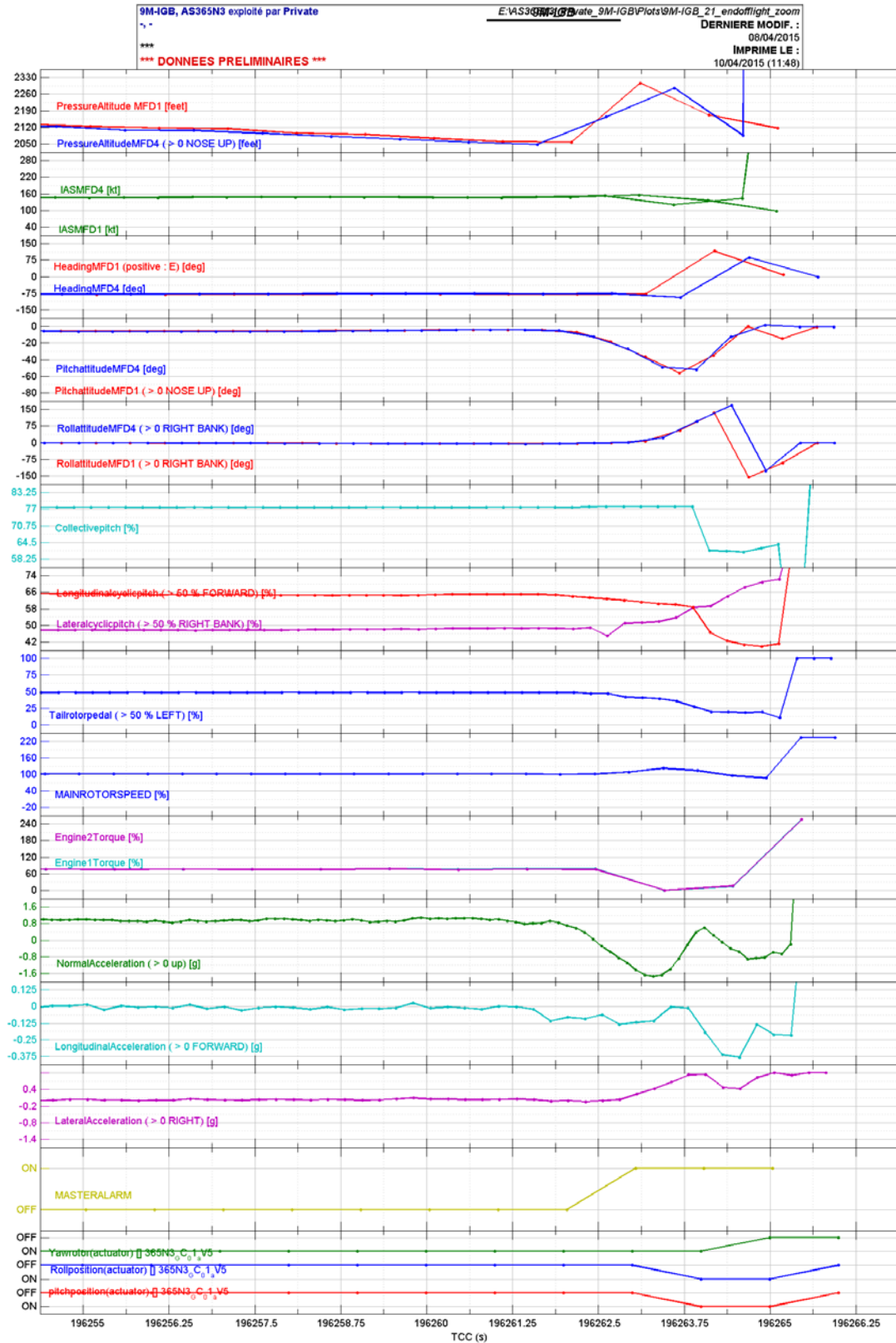



# ON GROUND OPEN FIELD PARAMETERS

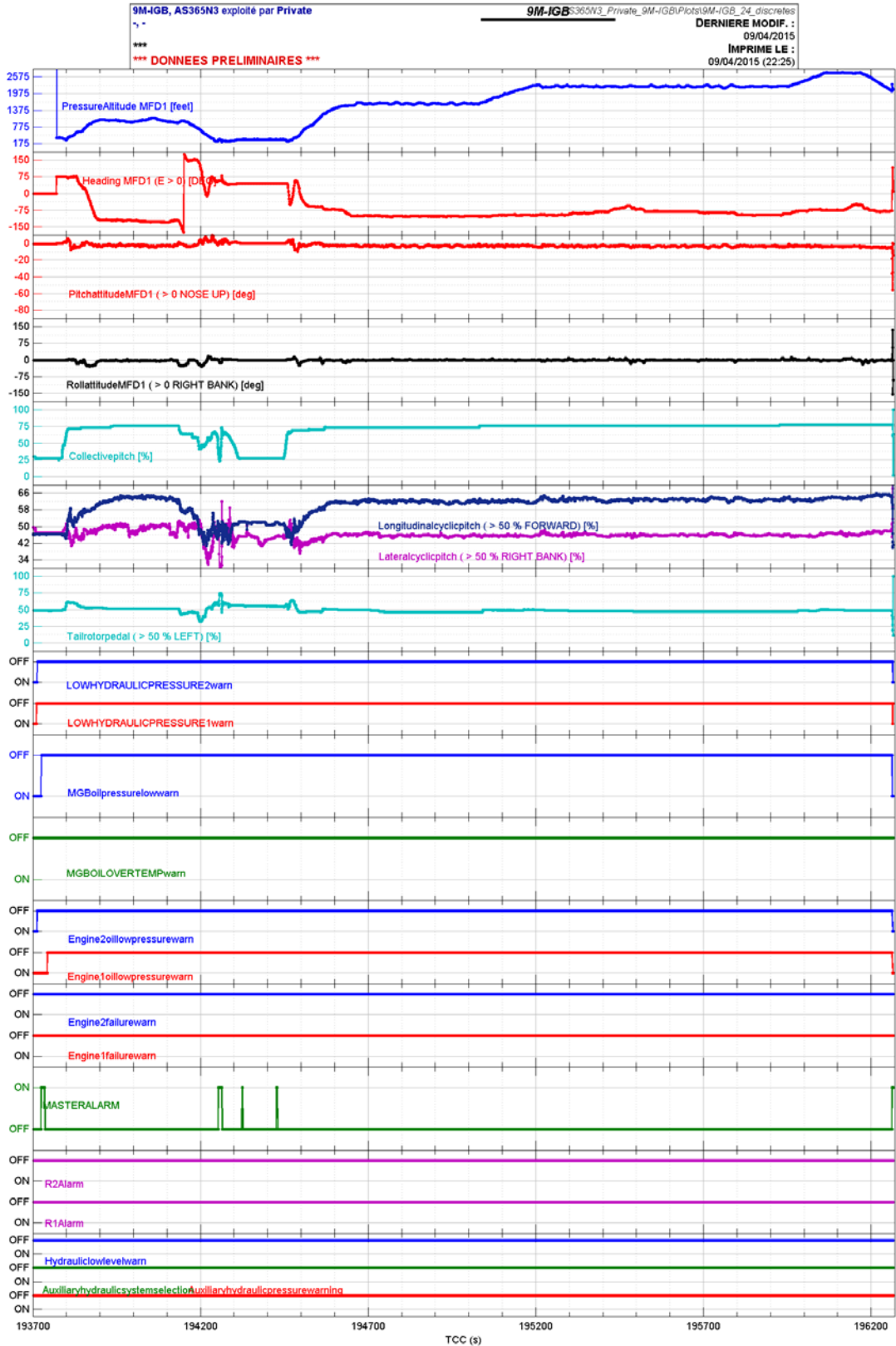

# END OF FLIGHT PARAMETERS

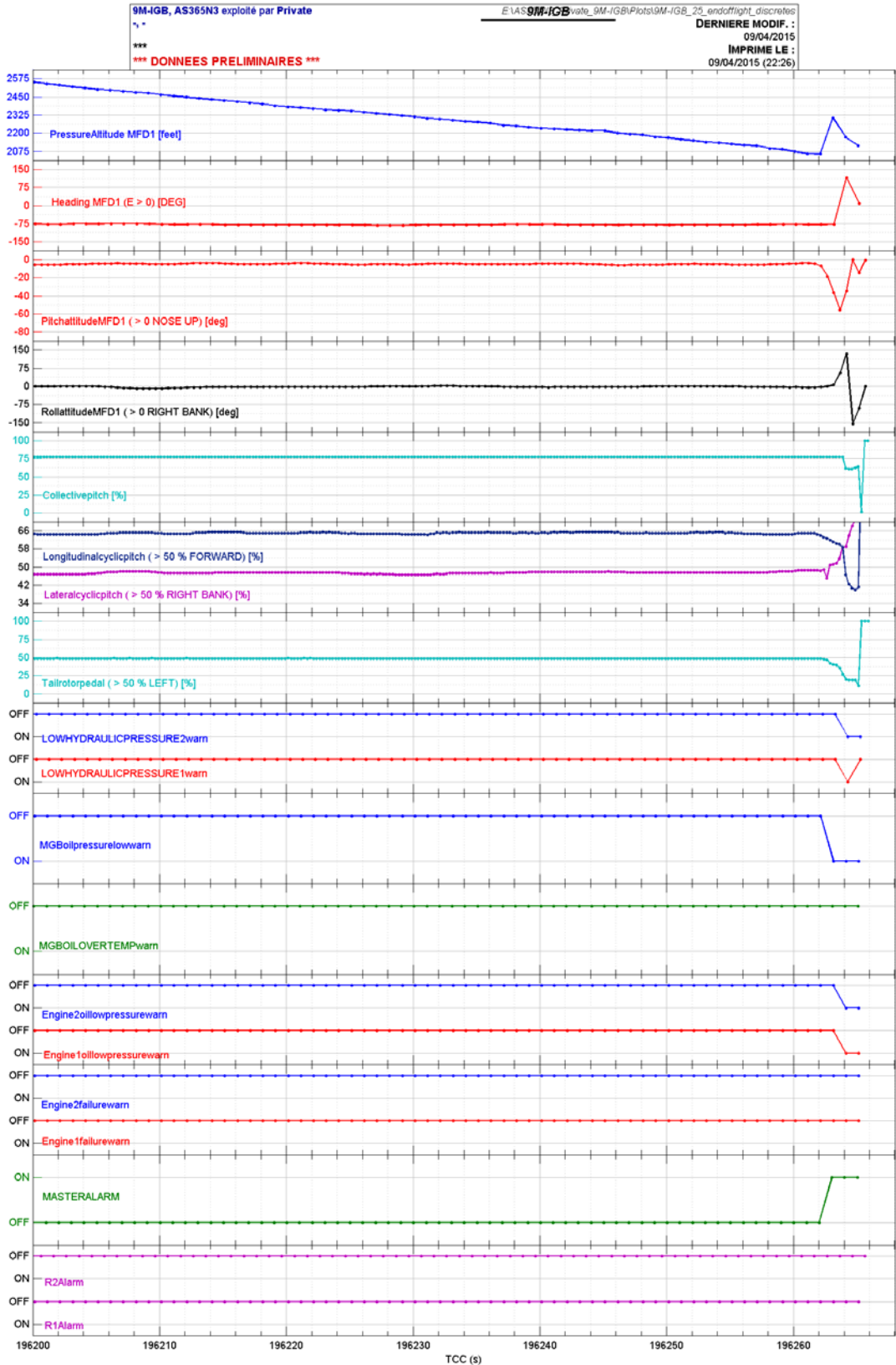

AFTER LANDING AT OPEN FIELD PARAMETERS

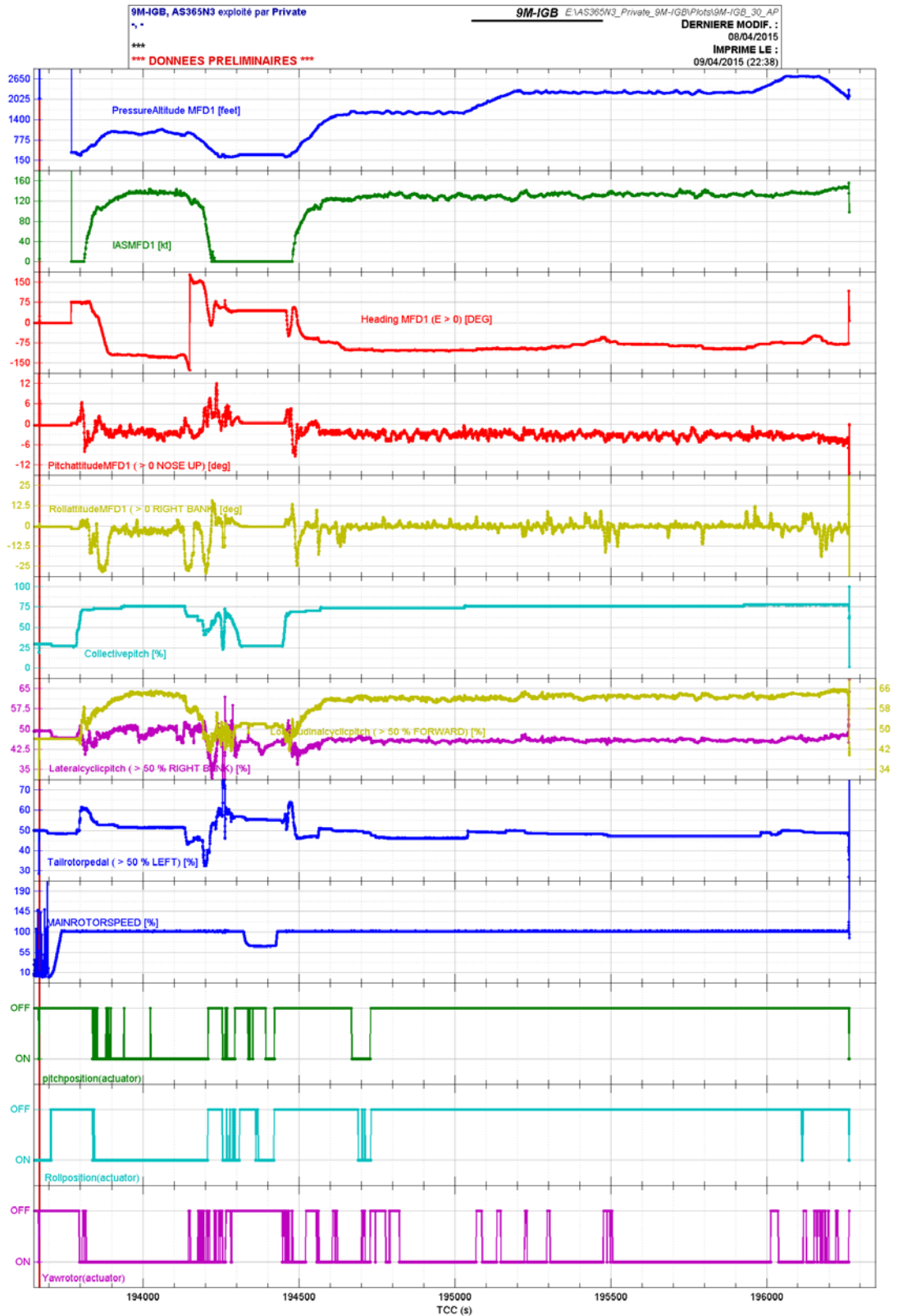

**PPL PRIVILEGES (CAR 1996)**

**5. Private Pilot's Licence (Helicopters and Gyroplanes)**

(1) Minimum age: 17 years.

(2) Maximum period of validity: (a) 24 months, if the holder is less than 40 years of age on the date on which the licence is granted or renewed; or (b) 12 months, if the holder is 40 years of age or more on that date.

(3) Privileges: The holder of the licence shall be entitled to fly as pilot-in-command or co-pilot of a helicopter or gyroplane of any of the types specified in the aircraft rating included in the licence: Provided that –

(a) he shall not fly such a helicopter or gyroplane for the purpose of public transport or aerial work other than aerial work which consists of –

(i) the giving of instruction in flying if his licence includes a flying instructor's rating or an assistant flying instructor's rating; or

(ii) the conducting of flying tests for the purpose of these Regulations; in either case in a helicopter or gyroplane owned, or operated under arrangements entered into, by a flying club of which the person giving the instruction or conducting the test and the person receiving the instruction or undergoing the test are both members;

(b) he shall not receive any remuneration for his services as a pilot on a flight other than remuneration for the giving of such instruction or the conducting of such flying tests as are specified in subitem (a);

(c) he shall not fly as pilot-in-command of such a gyroplane at night unless his licence includes a night rating (helicopters and gyroplanes) and he was within immediately preceding 90 days carried out as pilot-in-command not less than 5 take-offs and 5 landings at a time when the depression of the centre of the sun was not less than 120 below the horizon;

(d) he shall not fly as pilot-in-command of such a helicopter at night unless –

(i) his licence includes a night rating (helicopters and gyroplanes); and

(ii) his licence includes an instrument rating (helicopters) or he has written the immediately preceding 90 days carried as pilot-in-command not less than 5 flights, each consisting of a take-off, a transition from hover to forward flight, a climb to at least 500 feet and a landing, at time when the depression of the centre of the sun was not less than 120 below the horizon;

(e) he shall not unless his licence includes an instrument rating (helicopter) fly as pilot-in-command or co-pilot of such a helicopter flying in airspace notified for the purpose of this Schedule –

(i) in conditions such that he cannot comply with the specified minimum weather provisions; or

**PPL PRIVILEGES (CAR 1996)**

(ii) in circumstances which require compliance with the Instrument Flight Rules.

**6. Commercial Pilot's Licence (Helicopters and Gyroplanes)**

(1) Minimum age: 18 years.

(2) Maximum period of validity:

(a) 12 months, if the holder is less than 40 years of age on the date on which the licence is granted or renewed, or the date on which the licence is granted or renewed; or

(b) 6 months, if the holder is 40 years of age or more on that date.

(3) Privileges:

(a) The holder of the licence shall be entitled to exercise the privileges of a Private Pilot's Licence (Helicopters and Gyroplanes) which includes a night rating (helicopter and gyroplanes)

(b) He shall be entitled to fly as pilot in command of any helicopter or gyroplane specified in Part I of the aircraft rating included in the licence when the helicopter or gyroplane is engaged on a flight for any purpose whatsoever: Provided that –

(i) he shall not, unless his licence includes an instrument rating (helicopters) fly such a helicopter on any scheduled journey or on any flight for the purpose of public transport in conditions such that the helicopter cannot comply with the specified minimum weather provisions;

(ii) (aa) in the case of a person who is the holder of such a licence on 3 December 1989, then for so long as that licence or a renewal thereof is valid but not after 3 December 1994, he shall not fly such a helicopter or gyroplane on a flight for the purpose of public transport if its authorised maximum total weight exceeds 5700 kilogrammes; (bb) on or after 4 December 1994, and in the case of a person who is the holder of such a licence granted on or after 4 December 1989, not being a renewal of such a licence held on 3 December 1989 forthwith upon the grant of the licence, he shall not fly such a helicopter or gyroplane on a flight for the purpose of public transport unless it is certificated for a single pilot operation;

(iii) he shall not fly such a gyroplane at night unless he has within the immediately preceding 90 days carried out as pilot in command not less than 5 take-off and 5 landings at a time when the depression of the centre of the sun was not less than 120 below the horizon;

(iv) he shall not fly such a helicopter at night unless his licence includes an instrument rating (helicopters) or he has within the immediately preceding 90 days carried out as pilot-in-command not less than 5 flights, each consisting of take-off, a transition from hover to forward flight, a climb to at least 500 feet and landing, at a time when the depression of the centre of the sun was not less than 120 below the horizon;

### PPL PRIVILEGES (CAR 1996)

(v) he shall not fly such a helicopter or gyroplane on any flight for the purpose of public transport after he attains the age of 60 years unless the helicopter or gyroplane is fitted with dual controls and carries a second pilot who has not attained the age of 60 years and who holds an appropriate licence under these Regulations entitling him to act as pilot-in-command or co-pilot of that helicopter or gyroplane;

(vi) he shall not unless his licence includes an instrument rating (helicopters) to fly as pilot-in-command or copilot of such a helicopter flying in airspace notified for the purpose of this Schedule - (aa) in conditions such that he cannot comply with the specified minimum weather provisions; or (bb) in circumstances which require compliance with the Instrument Flight Rules. (c) He shall be entitled to fly as co-pilot of any helicopter or gyroplane specified in the aircraft rating included in the licence when the helicopter or gyroplane is engaged on a flight for any purpose whatsoever: Provided that he shall not act as co-pilot of any helicopter or gyroplane whose authorised maximum total weight exceeds 20,000 kilogrammes on any flight for the purpose of public transport after he attains the age of 60 years. (d) He shall not at any time after he attains the age of 65 years act as pilot-in-command or co-pilot of any helicopter or gyroplane on a flight for the purpose of public transport.



## DAILY INSPECTION AUTHORISATION

The following pilot (Aircraft Commander) has been trained by ECM personnel to carry out Daily Inspection on the helicopters listed below (refer e-mail) and is authorized to sign the Daily Inspection column of the respective Helicopter's Technical-Log, with the following **LIMITATIONS:**

- 1) Applicable to helicopters with the following Registrations ONLY: –
  - a) AS 365 N3 - 9M-IGB, S/N.: 6374.
- 2) All maintenance tasks identified in the Notice to Crew (NTC) are within prescribed limits.

No.	Name	Pilot's Lic/ Employee ID
1.	CAPT. CLIFFORD FOURNIER	CPL 2762/H

Authorised by :

Somanadhan KVB  
Quality Manager

04/01/2013

LANDING AT OPEN FIELD AT 08.20  
 BANK 13\*36"AND LH WHEEL SUNK 20 INCHES DEPTH  
 HELICOPTER REMAIN ON GROUND FOR 3 MIN. AND TAKE OFF AT 08.24

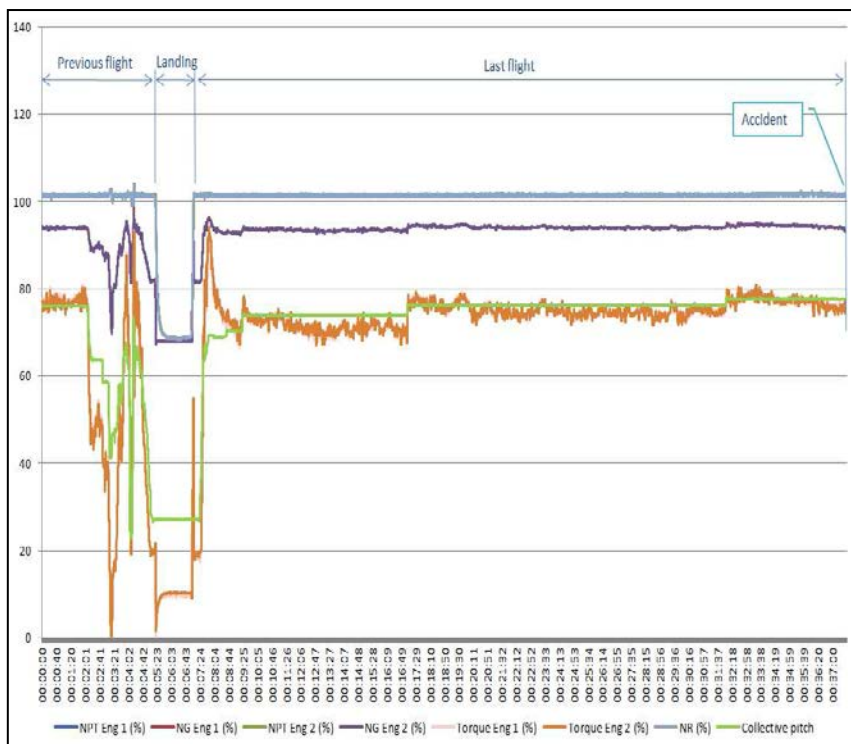

Outboard fin Ground clearance

Static equilibrium + Left landing gear in the soil of 38cm

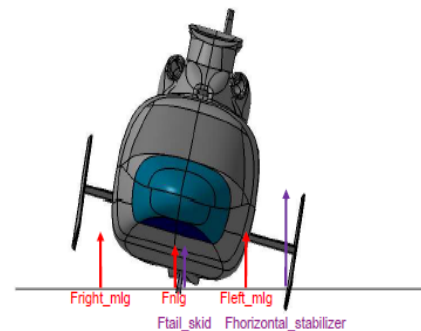

Static Equilibrium:  $F_{aircraft} = F_{right\_mlg} + F_{mlg} + F_{left\_mlg}$

+  $F_{horizontal\_stabilizer} + F_{tail\_skid}$





## FINAL DISINTERATION FROM FDR ANALYSIS

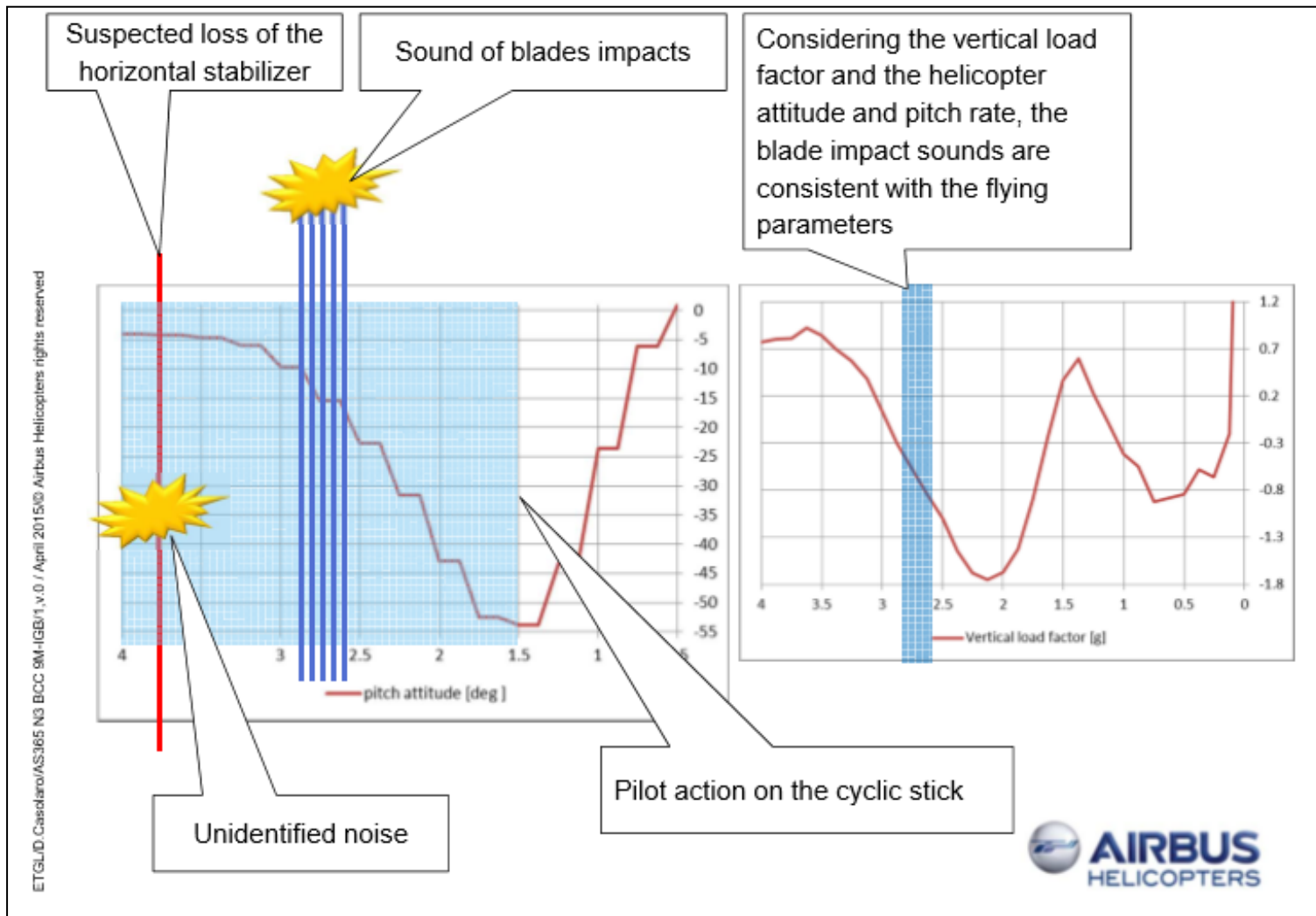



JABATAN PENERBANGAN AWAM MALAYSIA  
(DEPARTMENT OF CIVIL AVIATION MALAYSIA)  
ARAS 1-4, BLOK PODIUM  
NO. 27, PERSIARAN PERDANA, PRESINT 4  
PUSAT PENTADBIRAN KERAJAAN PERSEKUTUAN  
62618 PUTRAJAYA  
MALAYSIA

Telefon : 6-03-88714000  
Faks : 6-03-88901640  
AFTN : WMKKYAYX  
Teleks : PENAMA MA 30128  
Kawal : CIVIL KUALA LUMPUR  
Web : <http://www.dca.gov.my>



( 38 ) DCA/GPU/1/34

( 7 ) August 2015

See Distribution List,

Dear All,

**NOTIFICATION ON THE REQUIRED ACTIONS TO BE IMPLEMENTED BY  
PRIVATE HELICOPTER OPERATORS AND OWNERS FOLLOWING THE  
DAUPHIN AS365N3 9M-IGB ACCIDENT**

**1. GENERAL**

- 1.1 Preliminary report on the recent helicopter AS365N3 Dauphin 9M-IGB accident revealed several weakness. As such, the Aircraft Accident Investigation Bureau Malaysia has recommended several measures to be enforced by DCA Malaysia onto the private operators.
- 1.2 This is further re-enforced by Airbus Helicopters Safety Information Notice No. 2739-S-00 dated October 2014 and No. 2929-S-55 dated 28<sup>th</sup> July 2015 (as attached).

**2. REQUIREMENT**

- 2.1 All Private Category Operators are to observe flight operations limitations in their respective category as per the aircraft flight manuals or approved company's operations manual, whichever is more stringent.
- 2.2 Pre-flight preparation for every flight has to include risk assessment on the intended route, destination and landing points before the flight commences.
- 2.3 Pilot is to avoid landing at any unplanned places whether on their own or passenger's discretion except when absolutely necessary, such as in emergency situation.
- 2.4 All private flights need to have proper flight manifest as to ensure accountability especially in times of emergency.

**3. IMPLEMENTATION**

- 3.1 This notification takes effect immediately.

Thank you .

"BERKHIDMAT UNTUK NEGARA"

(DATU' SRI AZHARUDDIN BIN ABDUL RAHMAN)

Director General  
Department of Civil Aviation  
Malaysia

Distribution List:

Berjaya Air Sdn. Bhd  
Terminal 3, Lapangan Terbang Sultan Abdul Aziz Shah  
47200 Subang  
Selangor  
**(U.P: Chief Pilot)**

Pengurus Kanan Penerbangan  
Projek Lebuhraya Utara-Selatan Berhad (PLUS)  
Level 17 Menara 1  
Faber Towers  
Jalan Desa Bahagia  
Taman Desa  
Off Jalan Kelang Lama  
58100 K.L  
**(U.P: Chief Pilot)**

Weststar Aviation Services Sdn. Bhd  
No. 70 Jalan Ampang  
50450 Kuala Lumpur  
**(U.P: Chief Pilot)**

Danga Bay Sdn. Bhd  
C/O Airbus Helicopters Malaysia Sdn. Bhd  
Helicopter Centre  
Malaysia International Aerospace Centre  
Sultan Abdul Aziz Shah Airport  
47200 Subang  
Selangor Darul Ehsan  
**(U.P: Capt. Lee)**

Level B2, Menara Sunway  
Jalan Lagoón Timur  
Bandar Sunway  
46150 Petaling Jaya  
Selangor Darul Ehsan  
**(U.P: Capt. Ng Puay Cheng)**



No. 2929-S-55

## SAFETY INFORMATION NOTICE

### SUBJECT: STABILIZER(S)

In-flight loss of a horizontal stabilizer due to prior damage

For the attention of



AIRCRAFT CONCERNED	Version(s)	
	Civil	Military
AS365	N, N1, N2, N3	K, K2, F, F1, F3
SA366		GA
AS666		MA, MB, SA, SB, UB
EC155	B, B1	

Airbus Helicopters has participated in the investigations concerning an accident involving an AS365 N3 helicopter that was due to the in-flight loss of the LH part of the horizontal stabilizer.

Analyses and simulations carried out by Airbus Helicopters showed that the rupture of the LH part of the horizontal stabilizer was due to the LH side fin coming into contact with the ground during the landing preceding the accident.

This landing was carried out on loose soil, with the LH main landing gear sinking into the ground by 50 cm. This led to significant roll to the left (13°) and to the contact between the side fin and the ground, which caused severe damage to the horizontal stabilizer at the junction where it crosses the tail boom. In addition, a hydraulic fluid leakage had been observed by the pilot but no inspection was carried out on the helicopter before the subsequent take-off.

The purpose of this Safety Information Notice is to remind customers once again that any incident or event which occurs in flight or during the landing phase (exceedance of Flight Manual limitations, loss of hydraulic fluid, side fin impact on the ground, blade impact on foreign objects, etc.) must systematically lead to a detailed inspection, in order to ensure the helicopter's airworthiness before resuming flights.

In compliance with the regulations defined by the aviation authorities, Airbus Helicopters underlines the necessity to report any event which occurred during operations and/or maintenance and which has or could have an impact on flight safety.

Among the events related to operational maintenance and operating conditions, the impact of a structural component on the ground or on a foreign object is considered as an event which may affect flight safety. In October 2014, Safety Information Notice 2739-S-00 was issued to remind customers of these instructions.

For any questions concerning this subject, please contact the Airbus Helicopters Customer Service Technical Support Department at:

Tel: + 33 (0) 442.85.97.10  
 Fax: + 33 (0) 442.85.99.66  
 E-mail: [support.technical-airframe.ah@airbus.com](mailto:support.technical-airframe.ah@airbus.com)

**French Comments**  
**on the final report on the accident of the AS 365 N3 registered 9M-IGB near**  
**Subang Airport on April 4, 2016**

	Draft Final Report Reference	Text In The Report	Comments or Justification
1 From AH	Page 1 & all along the documents	"...Helicopter Dauphine,"	Replaced by "...Helicopter Dauphin,"(In French) or "...Helicopter Dolphin,"(In English)
2 From AH	Page 43	"Airbus Helicopter believes that the additional force (down load force) on the horizontal stabilizer causes it to break."	Removed this sentence because it is a summary and what Airbus Helicopters believes is exactly explained later.
3 From TM	Page 55, S 2.9	<<typical>>	Replace by atypical
4 From TM	Page 55, S 2.9	"Erratic values in the second of recording corresponds to the final moment of the crash nominal engine parameters during the final flight and Sudden changes in engines' parameters in last 3 seconds of recording. DECU reacts to the typical flight conditions."	We propose : Erratic values in the final second of recording corresponds to the final moment of the crash. Nominal engine parameters during the final flight and sudden changes in engines' parameters in last 3 seconds of recording when the DECU reacts to the atypical flight conditions."